

The logo features the word "Beta" in a bold, orange, sans-serif font. To its right, the word "Action" is written in a white, italicized, script font with a black outline. The "Action" text is set against a circular graphic element that resembles a target or a stylized 'C' with radiating lines.

# Beta Action



## AUTOMOTIVE

€

Promotion valid from 03/03/2025 to 29/08/2025  
Prices do not include V.A.T.

# 2025 1/2

# Beta

RECOGO 2.0



**Configure  
your workshop  
in 3D online**

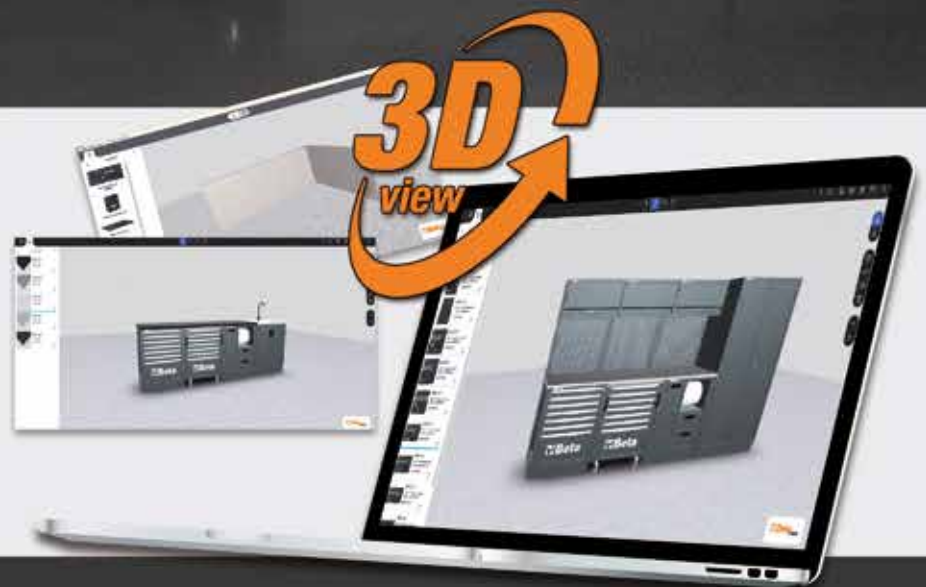



**WORKSHOP EQUIPMENT**  
2÷5

**CONTAINERS, WORKBENCHES AND TROLLEYS**  
6÷11

**ASSORTMENT AND SOFT THERMOFORMED TRAYS**  
12-13

**WRENCHES**  
14÷17

**SCREWDRIVERS**  
17

**SOCKETS**  
18-19

**TORQUE WRENCHES**  
20÷22

**PLIERS**  
22-23

**DRILLING AND THREADING TOOLS**  
23

**PULLERS**  
24

**HAMMERS AND CHISELS**  
25

**GENERAL MAINTENANCE**  
25-26

**MEASURING TOOLS**  
26

**BETA CHEMICALS**  
27

**LIGHTING**  
28-29

**POWER TOOLS**  
30-31

**ISULATED TOOLS**  
32-33

**REELS**  
34

**BATTERY CHARGERS**  
35÷41

**DIAGNOSTICS**  
40÷43

**OIL AND FILTERS**  
44÷46

**ENGINE**  
47÷50

**CLEANING**  
51

**WHEELS AND BRAKES**  
52÷57

**TRANSMISSION**  
57-58

**SUSPENSION**  
57-58

**BODYWORK**  
59÷62

**CAR CARE**  
63-64

**JACKS**  
65÷70

**ROBUR**  
70

**MOTORBIKE REPAIR**  
71

**BICYCLE TOOLS**  
72

**PNEUMATIC TOOLS**  
73÷78

**SAFETY FOOTWEAR**  
80÷84

**WORKWEAR**  
85÷88

**BETA COLLECTION**  
89

The images are for reference only. Beta Utensili S.p.A. reserves the right to update and upgrade its product range without notice.

Blister pack support

# RSC50 2.0

# NEW

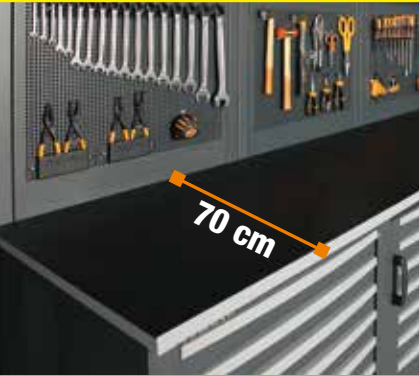

The workshop equipment combination, RSC50, has been upgraded into the new, **revolutionary RSC50 2.0**, with a **NEW 70-CM-DEEP WORKTOP**, for a large, convenient, functional work surface. It can be fitted with a vice, thereby allowing heavy-duty jobs to be carried out.



## COMBINATION RSC50 2.0 D

**NEW**  
**RSC50 2.0 D/223UT**  
 050001092

Workshop equipment combination RSC50 2.0 with 223 tools

Combination comprising the following:

- 1 worktop, 1,495x700 mm (RSC50 2.0 NPG/2-1.5MT)
- 1 fixed module with 7 drawers (RSC50 2.0 M7)
- 1 fixed two-door module (RSC50 2.0 MA)
- 2 wall-mounted cabinets (RSC50 2.0 PM)
- 2 upper perforated tool panels (RSC50 2.0 PFS)
- 2 lower perforated tool panels (RSC50 2.0 PFI)
- 2 pairs of right/left uprights (RSC50 2.0 P/2MDX-SX)
- 1 single-door tool cabinet (RSC50 2.0 A1)

Included in the price assortment of **223** **TOOLS** **Beta**  
 net value **1.429,00 €**

~~9.948,00 €~~  
**3.790,00 €**



276 kg

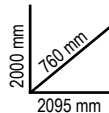

26



**M301**

29



**M302**

15



**M304**

153



**M306**

1/4"  
1/2"



# GET A NEW LOOK!

RENOVATE YOUR WORKSHOP  
**PURCHASE THE RSC50 2.0 D  
 OR RSC50 2.0 F COMBINATION**  
**...Beta WILL TAKE  
 CARE OF THE TOOLS!**



## COMBINATION RSC50 2.0 F

**NEW**  
**RSC50 2.0 F/445UT**  
 050001096

Included in the price assortment of **445**  
**TOOLS** Beta  
 net value  
**2.199,00 €**

### Workshop equipment combination RSC50 2.0 with 445 tools

Combination comprising the following:

- 1 worktop, 2,240x700 mm (RSC50 2.0 NPG/3-2.2MT)
- 1 fixed module with 7 drawers (RSC50 2.0 M7)
- 1 mobile roller cab with 7 drawers (RSC50 2.0 C7)
- 1 fixed service module with 2 drawers (RSC50 2.0 MS-2C)
- 3 wall-mounted cabinets (RSC50 2.0 PM)
- 3 upper perforated tool panels (RSC50 2.0 PFS)
- 3 lower perforated tool panels (RSC50 2.0 PFI)
- 3 pairs of right/left uprights (RSC50 2.0 P/2MDX-SX)
- 1 two-door tool cabinet (RSC50 2.0 A2)



411 kg



~~17.600,00 €~~  
**5.999,00 €**



M25



M304



M118



REVERSIBLE  
 IMPACT WRENCH  
 1927P



M105

14"  
 3/8"  
 12"



M66

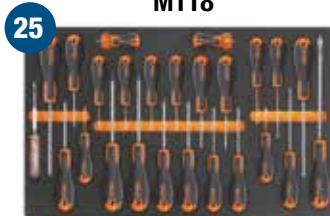

M213



M266

# C45PRO 2.0



## C45PRO 2.0 D

### Workshop equipment combination C45PRO 2.0 comprising:

- 1 fixed module with 7 drawers (C45PRO 2.0 M7)
- 1 mobile roller cab with 7 drawers (C45PRO 2.0 C7)
- 1 fixed service module (C45PRO 2.0 MS)
- 1 fixed module with 5 drawers (C45PRO 2.0 M5)
- 1 fixed two-door module (C45PRO 2.0 MA)
- 5 perforated tool panels (C45PRO 2.0 PF)
- 5 wall-mounted cupboards (C45PRO 2.0 PM)
- 7 wall brackets, wide type (C45PRO 2.0 SL)
- 2 wall brackets, narrow type (C45PRO 2.0 SS)
- 2 single-door cabinets (C45PRO 2.0 AS1)

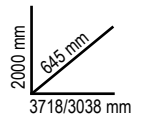

### C45PRO 2.0 DX

045002031

11.570,00 €  
**5.929,00 €**

- 1 stainless steel coated MDF worktop, dimensions 2,040x**615** mm (C45PRO 2.0 PXE/3-2.0MT)
- 1 stainless steel coated MDF worktop, dimensions 1,360x**615** mm (C45PRO 2.0 PXE/2-1.3MT)
- 1 self-supporting complete corner with stainless steel coated MDF worktop (C45PRO 2.0 CORNER/X)



640 kg

### C45PRO 2.0 DW

045002032

11.280,00 €  
**5.929,00 €**

- 1 multi-ply wood worktop, dimensions 2,040x**615** mm (C45PRO 2.0 PWE/3-2.0MT)
- 1 multi-ply wood worktop, dimensions 1,360x**615** mm (C45PRO 2.0 PWE/2-1.3MT)
- 1 self-supporting complete corner with multi-ply wood worktop (C45PRO 2.0 CORNER/W)



606 kg

## C45PRO 2.0 A

### Workshop equipment combination C45PRO 2.0

- Fixed service module (C45PRO 2.0 MS)
- Fixed module with 7 drawers (C45PRO 2.0 M7)
- Fixed two-door module (C45PRO 2.0 MA)
- 3 wall-mounted cabinets (C45PRO 2.0 PM)
- 3 perforated tool panels (C45PRO 2.0 PF)
- 2 wall brackets, narrow type (C45PRO 2.0 SS)
- 2 wall brackets, wide type (C45PRO 2.0 SL)

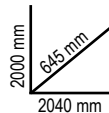

### C45PRO 2.0 AX

045002003

4.040,00 €  
**2.079,00 €**

- Stainless steel coated MDF worktop, dimensions 2,040x**615** mm (C45PRO 2.0 PXE/3-2.0MT)



234,50 kg

### C45PRO 2.0 AW

045002004

3.930,00 €  
**2.079,00 €**

- Multi-ply wood worktop, dimensions 2,040x**615** mm (C45PRO 2.0 PWE/3-2.0MT)

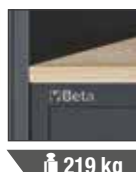

219 kg





# NEW

The workshop equipment system, C45PRO 2.0, has been upgraded into the C45PRO 2.0 system, an even more convenient one, **BASED ON THE NEW 61.5-CM DEEP WORKTOP** to answer the most demanding professionals' requirements.



## CONVENIENT AND PROFESSIONAL

### C45PRO 2.0

#### Workshop equipment combination C45PRO 2.0

- Fixed module with 7 drawers (C45PRO 2.0 M7)
- Mobile roller cab with 7 drawers (C45PRO 2.0 C7)
- Fixed service module (C45PRO 2.0 MS)
- 3 perforated tool panels (C45PRO 2.0 PF)
- 3 wall-mounted cabinets (C45PRO 2.0 PM)
- 3 wall brackets, wide type (C45PRO 2.0 SL)
- 1 wall bracket, narrow type (C45PRO 2.0 SS)
- Two-door cabinet (C45PRO 2.0 AS2)

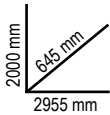

#### C45PRO 2.0 X

045002001

~~5.760,00 €~~  
**3.069,00 €**

- Stainless steel coated MDF worktop, dimensions 2,040x**615** mm (C45PRO 2.0 PXE/3-2,0MT)



#### C45PRO 2.0 W

045002002

~~5.650,00 €~~  
**3.069,00 €**

- Multi-ply wood worktop, dimensions 2.040x**615** mm (C45PRO 2.0 PWE/3-2,0MT)



### C45PRO 2.0 B

#### Workshop equipment combination C45PRO 2.0

- Fixed module with 5 drawers (C45PRO 2.0 M5)
- Fixed two-door module (C45PRO 2.0 MA)
- 2 wall-mounted cabinets (C45PRO 2.0 PM)
- 2 perforated tool panels (C45PRO 2.0 PF)
- 2 wall brackets, wide type (C45PRO 2.0 SL)
- 1 wall bracket, narrow type (C45PRO 2.0 SS)
- Single-door cabinet (C45PRO 2.0 AS1)

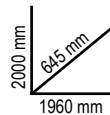

#### C45PRO 2.0 BX

045002021

~~3.620,00 €~~  
**1.859,00 €**

- Stainless steel coated MDF worktop, dimensions 1,360x**615** mm (C45PRO 2.0 PXE/2-1.3MT)



#### C45PRO 2.0 BW

045002022

~~3.510,00 €~~  
**1.859,00 €**

- Multi-ply wood worktop, dimensions 1,360x**615** mm (C45PRO 2.0 PWE/2-1.3MT)

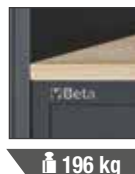

THE MOST COMPLETE **Beta** ASSORTMENT EVER  
AND THE ROLLER CAB RSC24 IS INCLUDED IN THE PRICE!

# THE MOST COMPLETE BETA ASSORTMENT EVER

2400 RSC24/8-VAL

024004007

Assortment of **445** tools for AUTOMOTIVE **14"** **38"** **12"**



M25



M304



M118



REVERSIBLE  
IMPACT WRENCH  
1927P



M105



M66



M213



M266

~~6.520,00 €~~

**2.199,00 €**

Save up  
to 4.321,00 €



Extra large version

**THE ROLLER CAB  
RSC24 IS INCLUDED  
IN THE PRICE!**

Mobile roller cab with  
**RSC24/8-F0**

- 8 removable drawers (588x367 mm), with ball bearing slides
- 6 drawers, 70 mm high
- 2 drawers, 140 mm high

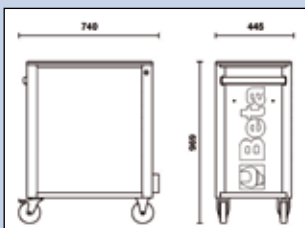

Promotion valid only  
with RSC24 FULL ORANGE



## 2400 RSC24/7-VAS

024004048

Assortment of **223** tools for *AUTOMOTIVE*  $\frac{1}{4}$ "  $\frac{1}{2}$ "

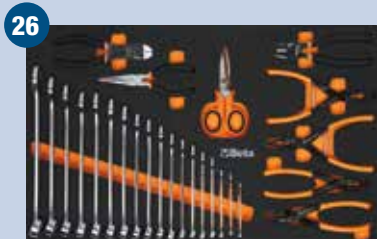

M301



M302



M304



M306

~~3.390,00 €~~  
**1.429,00 €**  
 Medium version

Save up  
 to 1.961,00 €

**THE ROLLER CAB RSC24 IS INCLUDED IN THE PRICE!**

Promotion valid only with RSC24 FULL ORANGE

**Mobile roller cab with RSC24/7-F0**  
 7 removable drawers (588x367 mm), with ball bearing slides:  
 • 5 drawers, 70 mm high  
 • 1 drawer, 140 mm high  
 • 1 drawer, 210 mm high



## RSC24

### Mobile Roller cab

- ABS reinforced worktop
- Multi-purpose top with anti-fall edges and eight holes for accommodating screwdrivers
- Drawer bases protected by foamed rubber mats
- 4 castors Ø 125 mm: 2 fixed and 2 steering (one with brake)
- Each drawer can accommodate up to 4 EVA foam or ABS thermoformed trays
- Front centralized safety lock
- Static load capacity: 800 kg
- Built-in bottle holder (can be applied on both sides).

The following accessories can be added:

- Wood worktop 2400 RSC24/PL
- Perforated tool panel 2400 RSC24/PF
- Folding shelf 2400 RSC24/MP
- Document holder 2400 RSC24/PD
- Paper roll holder 2400 RSC24/PC
- Computer wall bracket 2400 RSC24/SPC

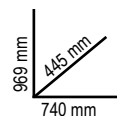

	Ral 2011	Ral 2011	Ral 9006	Ral 3000	Ral 5015	Ral 7016	Ral 9005	kg	€
		Ral 7016	Ral 7016	Ral 7016	Ral 7016				
<b>RSC24/5</b>	024004050	024004051	024004052	024004053	024004056	024004057	024004059	60	<del>1.044,00 €</del> <b>571,00 €</b>
<b>RSC24/6</b>	024004060	024004061	024004062	024004063	024004066	024004067	024004069	62	<del>1.124,00 €</del> <b>637,00 €</b>
<b>RSC24/7</b>	024004070	024004071	024004072	024004073	024004076	024004077	024004079	63	<del>1.218,00 €</del> <b>681,00 €</b>
<b>RSC24/8</b>	024004080	024004081	024004082	024004083	024004086	024004087	024004089	66	<del>1.305,00 €</del> <b>736,00 €</b>

## RSC24AXL

### Mobile roller cab, WITH ANTI-TILT SYSTEM, long model

- New ABS reinforced worktop with anti-fall edges, eight holes for accommodating screwdrivers and 6 tote trays
- Sturdy nylon front, with built-in label holder.
- Drawer bases protected by foamed rubber mats
- 4 castors, Ø 125 mm: 2 fixed and 2 steering (one with brake)
- Front centralized safety lock
- Built-in side bottle holder (can be applied on both sides)
- Each drawer can accommodate up to 6 EVA foam or ABS thermoformed trays

#### Following accessories can be added:

- Wood worktop 2400 RSC24/PL
- Document holder 2400 RSC24/PD-A
- Paper roll holder 2400 RSC24/PC-A



	Ral 2011	Ral 3000	Ral 7016	n°	↓ max	kg	€
	Ral 7016	Ral 7016	Ral 7016				
<b>RSC24AXL/7</b>	024004271	024004273	024004277	5	70 mm	30 kg	
				1	140 mm	35 kg	<del>1.700,00 €</del>
				1	210 mm	35 kg	<b>967,00 €</b>
<b>RSC24AXL/8</b>	024004281	024004283	024004287	6	70 mm	30 kg	
				2	140 mm	35 kg	<del>1.820,00 €</del>
				8	70 mm	30 kg	<b>1.033,00 €</b>
<b>RSC24AXL/9</b>	024004291	024004293	024004297	1	140 mm	35 kg	<del>1.935,00 €</del>
				1	140 mm	35 kg	<b>1.099,00 €</b>



## RSC28

### SuperTank trolley with wood worktop and 10 drawers

- 10 drawers (588x367 mm) with ball bearing slides
- Quick, safe system for opening and closing drawers, with nylon and fibreglass front
- **5 side drawers:**
  - 4 drawers, 70 mm high
  - 1 drawer, 210 mm high
- **5 front drawers:**
  - 4 drawers, 70 mm high
  - 1 drawer, 210 mm high
- Drawer bases protected by foamed rubber mats.
- 4 high-capacity castors, Ø 150 mm: 2 fixed and 2 steering with brakes
- 2 centralized safety locks
- 3 front tool drawers
- Multi-ply wood worktop with holes for a vice (1599F/150 - 1599GI/150, to be ordered separately)
- Built-in tool compartment



	Ral 2011	Ral 7016	Ral 3000	n°	↓ Max
	028003001	028003007	028003003	8	70 mm
				2	210 mm
					30 kg

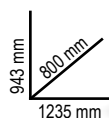

- Side compartment with foldaway door with lock
- Built-in bottle holders
- 135-mm-high storage compartment with plastic-covered base





**NEW**

## RSC24AXXL

2.420,00 €  
**1.379,00 €**

### Mobile roller cab with 8 drawers and anti-tilt system, long model

- 1 fully removable drawer (1,176x367 mm), with ball bearing slides
- 7 fully removable drawers (882x367 mm), with ball bearing slides:
  - 6 drawers 70 mm high
  - 1 drawer 140 mm high

131 kg

1100 kg

- Worktop made from stainless steel coated MDF, with holes for vice item 1599F/125 or 1599GI/125 (to be ordered separately) and 6 tote trays
- Sturdy nylon fronts, with built-in label holders
- Drawer bases protected by foamed rubber mats
- Removable side compartment, with ball bearing slides, with shelf and lock
- 4 castors, Ø 150 mm: 2 fixed and 2 steering with brakes
- 3 safety locks
- Built-in paper roll holder
- Built-in bottle holder
- Static load capacity: 1,100 kg

- Following trays can be added:
  - up to 8 EVA foam or ABS thermoformed trays in drawer 1,176x367 mm
  - up to 6 EVA foam or ABS thermoformed trays in drawer 882x367 mm



n°		Max
1	70 mm (1.176x367 mm)	40 kg
6	70 mm (882x367 mm)	30 kg
1	140 mm (882x367 mm)	35 kg

Ral 2011	Ral 3000	Ral 7016
024004781	024004783	024004787

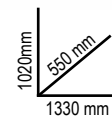
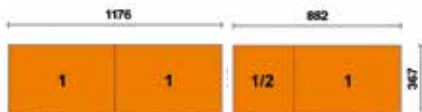

## C45PRO 2.0 MWS

### Work Station roller cab with 7 drawers and built-in waste bin

- 1 drawer (1248x406 mm) with ball bearing slides
- 6 drawers (782x406 mm) with ball bearing slides:
  - 5 drawers 65 mm high
  - 1 drawer 145 mm high
- Drawer bases protected by foamed rubber mats
- Can be fitted with thermoformed trays
- Storage compartment with intermediate shelf and door, interior dimensions 504x424x597 mm
- Built-in waste bin
- Built-in paper roll compartment
- 4 heavy-duty castors, Ø 150 mm, 2 fixed and 2 steering with brakes
- Front centralised lock
- Can accommodate a vice (1599P/150, to be ordered separately)

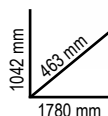

n°		Max
5	65 mm	25 kg
1	105 mm	40 kg
1	145 mm	30 kg

### C45PRO 2.0 MWS/X

1.955,00 €  
**1.049,00 €**

045000181

- Worktop (1680 mm) made of stainless steel coated MDF

126 kg



### C45PRO 2.0 MWS/W

1.905,00 €  
**1.049,00 €**

045000191

- Multi-ply wood worktop (1680 mm)

122 kg



# NEW RANGE OF WORKBENCHES

# NEW MODULAR

Beta has launched the new range of workbenches, MODULAR, designed to make it possible for professionals to configure their workplaces from scratch, adapting them to their individual needs



- Worktop (2,100x750 mm) made from multi-ply wood, 38 mm thick
- Front centralized lock
- Steel frame with 4 supporting legs
- Holes for a vice (1599F/150 - 1599G/150, to be ordered separately)
- 2 lower half-shelves for objects, 1,788x335 mm; thickness: 40 mm
- Static load capacity: 800 kg, evenly distributed
- Can be fixed to floor

- Kit with 4 perforated tool panels, comprising the following:
- 3 supporting brackets
  - 6 400-mm uprights
  - 2 1,015-mm supports; can accommodate 1 19" rack multi-socket (not included)
  - 4 perforated tool panels, 1,015x25x400 mm



## C58BC-W2,1 4C+SVR

2.045,00 €  
1.099,00 €

Workbench, 2.1 m long, with wood worktop, with 4 drawers

- 4 drawers (367x588 mm) with ball bearing slides: 2 drawers 70 mm high, 2 drawers 140 mm high.
- Drawer bases protected by foamed rubber mats

- Each drawer can accommodate up to 4 EVA foam or ABS thermoformed trays



Ral 2011	Ral 7016
Ral 7016	
058000723	058000727



## C58BC-W2,1 4CA+SVR

2.275,00 €  
1.219,00 €

Workbench, 2.1 m long, with wood worktop, 4 drawers and door module

- 1 module with door and lock
- 4 drawers (367x588 mm) with ball bearing slides: 2 drawers 70 mm high, 2 drawers 140 mm high.
- Drawer bases protected by foamed rubber mats

- Each drawer can accommodate up to 4 EVA foam or ABS thermoformed trays



Ral 2011	Ral 7016
Ral 7016	
058000733	058000738



### RSC51

#### Service tool trolley with 3 drawers

- 3 drawers (588x367 mm) with ball bearing slides, 70 mm high
- ABS reinforced worktop, solid and sturdy
- Multipurpose top with anti-fall edges and 8 holes for accommodating screwdrivers
- Drawer bases protected by foamed rubber mats
- Each drawer can accommodate up to **4 EVA foam or ABS thermoformed trays**
- Front centralized safety lock
- Convenient side screwdriver holder included
- Two built-in side spray can holders
- Large lower shelf protected by an anti-oil and anti-petrol rubber mat
- 4 castors, Ø 125 mm: 2 fixed castors and 2 swivel castors (one with brake)
- Capacity of each drawer: 15 kg, evenly distributed

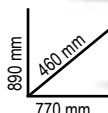

kg  
400



38 kg

688,00 €  
**380,00 €**

n°	mm	Max
3	70 mm	15 kg



Ral 2011	Ral 3000	Ral 7016
051000300	051000303	051000307

### C51

#### Trolley

- 3 tops covered in antislip ribbed rubber
- Two fixing options for central worktop
- Four castors Ø 100 mm: 2 fixed and 2 steering (1 with brake)

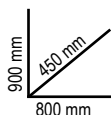

344,00 €  
**193,00 €**

kg  
200



21 kg



Ral 2011	Ral 7016	Ral 3000
051000001	051000002	051000003

### C25

#### Tank trolley with shelf

- Foldaway lid
- 1 sliding drawer
- Tool tray protected by foamed rubber mats
- Shelves protected by oil and fuel proof mats
- Four castors 100 mm in Ø: 2 fixed and 2 swivelling (one with brake)
- Safety lock
- One more shelf M4 can be added on the opposite side.
- Empty thermoformed tray for 1/2" sockets and accessories (024990104)
- Paper roll holder item 2499PC can also be included

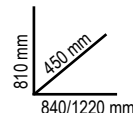

788,00 €  
**428,00 €**

025000001



31,5 kg



### 3069

030690000

#### Manual pallet truck

##### Features:

- 2 steering wheels, 200x50 mm, made of PU
- Double front rollers, 80x70 mm, made of PU
- Pallet access entry and exit rollers
- Depth stop notch
  - Lowering speed control valve
  - Safety overload valve
  - **3-position operating lever**

##### Technical data:

- Maximum capacity: 2500 kg
- Overall length: 1550 mm
- Fork length: 1150 mm
- Fork width: 540 mm
- Individual fork width: 160 mm
- Lever height: 1230 mm
- Max. lifting height: 115 mm
- Pallet storage corridor: 800x1200 lengthwise: 1805 mm
- Turning radius: 1347 mm

kg  
2500

69,5 kg

1150 mm

869,00 €  
**389,00 €**





## 5904VA/T

059040416

1.950,00 €  
1.089,00 €

Assortment of 102 tools in foam trays

12<sup>99</sup>

**Quantity/Description**

Quantity	Description	Beta N.	TR
21	combination wrenches 6-7-8-9-10-11-12-13-14-15-16-17-18-19-20-21-22-24-27-30-32 mm		42 T05 +T06
8	combination wrenches 6x7-8x9-10x11-12x13-14x15-16x17-18x19-20x22 mm		55 T33
9	offset hexagon key wrenches $\varnothing$ 1,5 $\pm$ 10 mm	96/SC9	T33
6	offset hexagon key wrenches $\varnothing$ 2-2,5-3-4-5-6 mm	96T	T52
8	T - handle wrenches with swivelling socket $\varnothing$ 7-8-10-12-13-14-17-19 mm	952	T63
19	1/2" square drive hexagon sockets $\varnothing$ 10-11-12-13-14-15-16-17-18-19-20-21-22-23-24-26-27-30-32 mm	920A	T83
1	1/2" drive extension bar 125 mm	920/21	T83
1	1/2" drive extension bar 255 mm	920/22	T83
1	1/2" drive universal joint	920/25	T83
1	1/2" drive sliding T-handle 305 mm	920/42	T83
1	1/2" drive reversible ratchet $\otimes$	920/55	T83
1	heavy-duty diagonal cutting nippers $\nabla$ 160 mm	1084BM	T137
1	combination pliers bright chrome-plated, bi-material handles $\equiv$ 180 mm	1150BM	T137
1	Extra-long needle nose pliers $\bullet$ 160 mm	1166BM	T137
1	circlip pliers straight, internal $\odot$ 180 mm	1032	T145
1	circlip pliers bent, internal $\odot$ 170 mm	1034	T145
1	circlip pliers straight, external $\bullet$ 175 mm	1036	T145
1	circlip pliers bent, external $\bullet$ 175 mm	1038	T145
1	self - locking pliers 240 mm	1052	T153
1	slip joint pliers, slip-proof PVC coated handles 250 mm	1048N	T153
7	screwdrivers for slotted head screws $\bullet$ 2,5x50 -3x75 - 3,5x100 - 4x125 -5,5x100 - 5,5x150 - 6,5x150 mm	1262	T202
6	screwdrivers for cross head Phillips® screws $\oplus$ PH0x60 - PH0x100 - PH1x80 - PH1x120 - PH2x100 - PH2x150 mm		
2	flat chisels, ribbed type 100-200 mm	35	T234
1	engineer's hammer 300 g	1370	T234
1	soft face hammer $\varnothing$ 35 mm	1390	T234
1	empty thermoformed tray		VP5

Recommended with: RSC23T - RSC24 - RSC24A - RSC24AXL - RSC24AXL/P7 - RSC24AXXL - RSC24L/7- RSC24L-CAB - C37 - C39 - C39SM - C39MD - RSC28 - C59 - C58BC - RSC55 - RSC50 2.0



## M01

024500001

497,00 €  
289,00 €



42 6-7-8-9-10-11-12-13-14-15-16-17-18-19-20-21-22-24-27-30-32-36 mm

## M05

024500005

245,00 €  
138,00 €

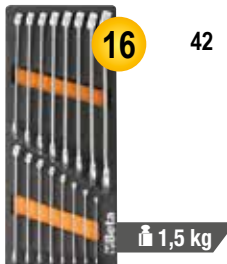

6-7-8-9-10-11-12-13-14-15-16-17-18-19-20-21 mm

## M45

024500045

360,00 €  
204,00 €



8-9-10-11-12-13-14-15-16-17-18-19 mm

## M46

024500046

424,00 €  
219,00 €



8-9-10-11-12-13-14-15-16-17-18-19 mm

## M50

024500050

146,00 €  
83,00 €



96T  $\varnothing$  2-2,5-3-4-5-6-7-8 mm

## M55

024500055

96,00 €  
55,00 €

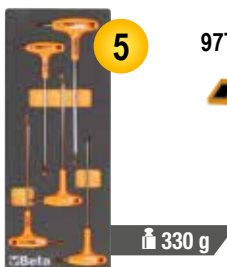

97TTX  $\varnothing$  T10-T15-T20-T25-T30

## M63

024500063

387,00 €  
227,00 €



$\varnothing$  952 7-8-10-12-13-14-17-19 mm

**M69**

024500069

331,00 €  
**186,00 €**

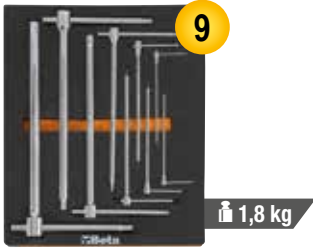

9

○ 951 2,5-3-4-5-6-8-10-12-14 mm

1,8 kg

**M118**

024500118

1.113,00 €  
**549,00 €**



33

8 kg

FOR 140 MM DRAWERS

- 1927P 1750 Nm
- 720L ○ 13-17-19-21-22-24 mm
- 720ME ○ 5-6-8-10-12-14-17-19 mm
- 720 ○ 10-12-13-14-15-16-17-18-19-21-22-24-27-30-32 mm
- 720LC ○ 17-19-21 mm

**M100**

024500100

1.350,00 €  
**659,00 €**



98

6,7 kg

14" 12"

- 895/1 - 895/3 - 895/6
- 900 4-4,5-5-5,5-6-7-8-9-10-11-12-13-14 mm
- 900L 5-6-7-8-9-10-11-12-13 mm
- 900ME 3-4-5-6-7 mm
- 900LP 0,8x4-1x5,5-1,2x6,5-1,2x8 mm
- 900PH PH1-PH2-PH3-PH4
- 900TX T10-T15-T20-T25-T27-T30-T40
- 900/20 50 mm - 900/20L 100 mm
- 900/21 150 mm
- 900/25
- 900BG/30
- 900/42
- 900/55
- 920A 8-10-11-12-13-14-15-16-17-18-19-20-21-22-23-24-26-27-28-30-32 mm
- 920/15 - 920/25
- 920AN/125 125 mm
- 920AN/250 250 mm
- 920/42
- 920/55
- 920FTX 10-12-14-16-18-20-22-24 mm
- 920AL 10-12-13-14-15-16-17-18-19-21-22 mm

**M129**

024500129

494,00 €  
**296,00 €**



13

3,4 kg

- 1032 180 mm
- 1034 170 mm
- 1036 175 mm
- 1038 175 mm
- 1048N 250 mm
- 1052 240 mm
- 1082BM 160 mm
- 1098 220 mm
- 1112 250 mm
- 1128BM 145 mm
- 1150BM 180 mm
- 1166BM 160 mm
- 1168BM 160 mm

**M213**

024500213

245,00 €  
**142,00 €**

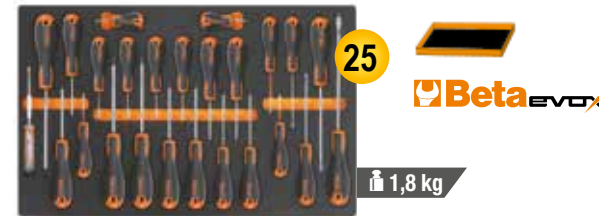

25

Beta evox

1,8 kg

- 1201E 2,5x50-3x75-4x100-5,5x125-6,5x150-8x200 mm
- 1201EN 4x30 mm
- 1202E PH0x60-PH1x80-PH2x100-PH3x150 mm
- 1202EN PH1x30 mm
- 1207E/TX T6-T7-T8-T9-T10-T15-T20-T25-T27-T30-T40-T45
- 1253 3,5x100 mm

**M105**

024500871

1.470,00 €  
**714,00 €**



116

7,7 kg

14" 38" 12"

- 900 4-4,5-5-5,5-6-7-8-9-10-11-12-13-14 mm
- 900L 5-6-7-8-9-10-11-12-13 mm
- 96BPC/SC9 1,5-2-2,5-3-4-5-6-8-10 mm
- 895/1 - 895/3 - 895/6
- 900ME 3-4-5-6-7 mm
- 900LP 0,8x4-1x5,5-1,2x6,5-1,2x8 mm
- 900PH PH1-PH2-PH3-PH4
- 900TX T10-T15-T20-T25-T27-T30-T40
- 900/16 □ 1/4 - ■ 3/8
- 900/... 50-100-150 mm
- 900/25 - 900BG/30 - 900/42
- 900/55
- 910A 6-7-8-9-10-11-12-13-14-15-16-17-18-19-20-21-22 mm
- 910/15 □ 3/8 - ■ 1/4
- 910/16 □ 3/8 - ■ 1/2
- 910/21 125 mm
- 910/22 250 mm
- 910/25 - 910/42
- 910/55
- 920A 8-10-11-12-13-14-15-16-17-18-19-20-21-22-23-24-26-27-28-30-32 mm
- 920/15 □ 1/2 - ■ 3/8
- 920/25
- 920AN 125 - 250 mm
- 920/42
- 920/55
- 956E 16-17,8-20,8 mm

**M230**

024500230

467,00 €  
**270,00 €**



25

3,2 kg

- 30 Ø 2-3-4 mm
- 31 Ø 2-3-4-5-6-8 mm
- 32 Ø 4 mm
- 34 150 mm
- 35 200-250 mm
- 36 125 mm
- 1370 500 g
- 1390 Ø 35 mm
- 1692 3 m
- 1712
- 1719BMA/Q 200 mm
- ▲ 1719BMA/T 200 mm
- 1719BMA/P 200 mm
- ▶ 1719BMA/M 200 mm
- 1719BMA/R 200 mm
- 1737NX
- 1771 170 mm

**42**

**BETA'S ICONIC WRENCH**

*A stylish, slim shape enhanced by a slender profile, lighter to the touch.*

The strength, resilience and ergonomic design of the Beta wrench reach even higher values, to provide users with the best possible tool. The manufacturing process is carried out in our factories in Sovico and Sulmona, on the basis of state-of-the-art automation technology and the best trained workers.

**ERGONOMIC**

The offset ring has a 15 degree angle to protect the hand. The shape is obtained from a die; it is not bent later.



**POWERFUL**

Torque values more than doubled compared to the requirements to be satisfied under ISO 1711.

**STRENGTH**

Remarkable strength: in case of improper use, the wrench buckles, without breaking suddenly and dangerously.



**42/SP15**

000421078

217,00 €  
**120,00 €**

**Set of 15 combination wrenches with holder**

6-7-8-9-10-11-12-13-14-15-16-17-19-22-24 mm



**42/SP25**

000421085

536,00 €  
**307,00 €**

**Set of 25 combination wrenches with holder**

6-7-8-9-10-11-12-13-14-15-16-17-18-19-20-21-22-23-24-25-26-27-28-30-32 mm



**55/B12N**

000550164

168,00 €  
**98,00 €**

**Set of 12 double open end wrenches in roll-up wallet made of durable polyester**

6x7-8x9-10x11-12x13-14x15-16x17-18x19-20x22-21x23-24x26-25x28-30x32 mm



**83/S5**

000830085

150,50 €  
**86,00 €**

**Set of 5 half-moon ring wrenches**

10x12-11x13-15x17-16x18-19x22 mm



**90/B8N**

000900156

141,50 €  
**83,00 €**

**Set of 8 double ended deep offset ring wrenches in roll-up wallet made of durable polyester**

6x7-8x9-10x11-12x13-14x15-16x17-18x19-20x22 mm





**142SN/SC9**

001420259

~~293,00 €~~  
**168,00 €**

**Set of 9 swivel end ratcheting combination wrenches, with compact support**

8-10-11-12-13-14-15-17-19 mm



**142/SC9I**

001420087

~~244,00 €~~  
**140,00 €**

**Set of 9 reversible ratcheting combination wrenches, with compact support**

8-10-11-12-13-14-15-17-19 mm



**141/B9**

001410069

~~215,00 €~~  
**109,00 €**

**Set of 9 ratcheting combination wrenches, straight series in wallet**

8-10-11-12-13-14-15-17-19 mm



**94/S6**

000940050

~~144,50 €~~  
**65,00 €**

**Set of 6 flare nut open ring wrenches**

8x10-10x11-11x13-12x14-17x19-19x22 mm



**95FTX/S4**

000950325

~~63,50 €~~  
**32,00 €**

**Set of 4 double-ended straight wrenches, for Torx® head screws**

E6xE8-E10xE12  
E14xE18-E20xE24



**186 8-32**

001860008

~~55,50 €~~  
**32,00 €**

**Self-locking wrench with automatic take-up device for hexagons, 8 to 32 mm**

Ideal for hexagon, Spline, square and Torx® head screws, including damaged screws



L 260 mm



**951/S6** ~~145,50 €~~  
009510687 **82,00 €**

**Set of 6 T-handle wrenches with three hexagon male ends**



**952/D7** ~~282,00 €~~  
009520079 **164,00 €**

**Set of 7 T-handle wrenches with swivelling hexagon sockets**



**NEW**  
**96BP-H0/SC9** ~~54,80 €~~  
000961254 **26,00 €**

**Set of 9 ball head offset hexagon key wrenches, with screw holding system**



**96BPC/SC9** ~~59,00 €~~  
000960354 **25,00 €**

**Set of 9 ball head offset hexagon key wrenches**

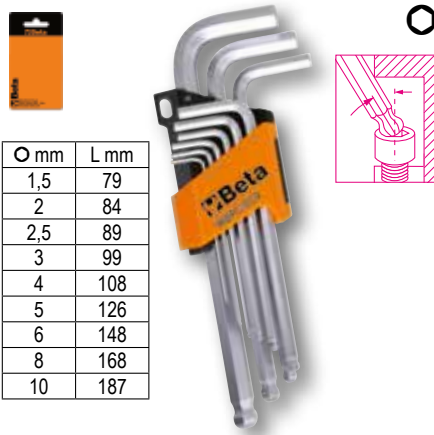

**97BTX/SC8** ~~89,50 €~~  
000970164 **48,00 €**

**Set of 8 ball head offset key wrenches, long model, for Torx® head screws**

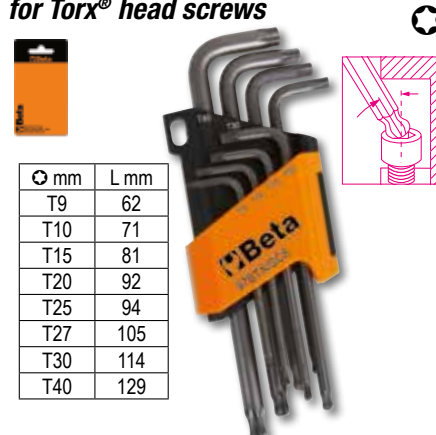

**97BRTXL/SC8** ~~104,50 €~~  
000970464 **50,00 €**

**Set of 8 ball head offset key wrenches, long model, for Tamper Resistant Torx® head screws**



**96T/S5P** ~~72,00 €~~  
000960946 **41,00 €**

**Set of 5 offset hexagon key wrenches with handles**



**97TTX/S6** ~~102,50 €~~  
000970791 **54,00 €**

**Set of 6 ball head offset key wrenches for Torx® head screws with handles**



## 951GP/S6

009511687

~~181,00 €~~  
89,00 €

Set of 6 T-handle wrenches with one hexagon male end

3-4-5-6-8-10 mm



## 920/40

009200850

~~67,00 €~~  
39,00 €

1/2" drive swivel T-handle

L mm	A mm
490	230

1 1/2"

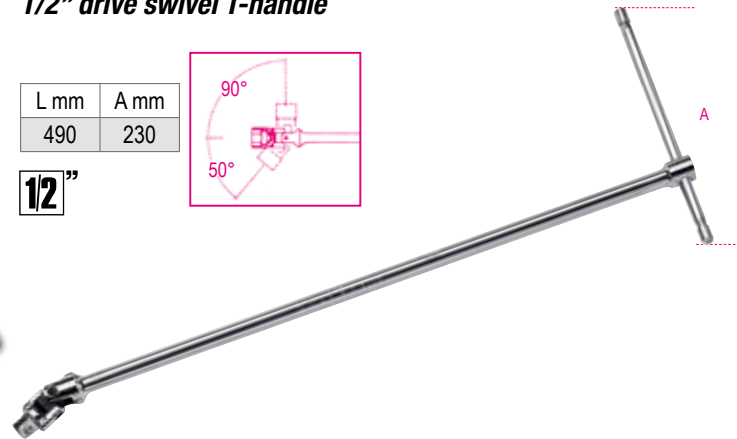
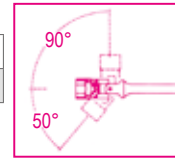

## 1203E/D8P

012031018

~~49,00 €~~  
28,00 €

Sada 8 šroubováků Evox

1201E 2,5x50-3x75-4x100-5,5x100-6,5x150 mm  
1202E PH0x60-PH1x80-PH2x100 mm



## 1203E/D10N

012031019

~~62,50 €~~  
36,00 €

Sada 10 šroubováků Evox

1201E 2,5x50-3x75-4x100-5,5x150-6,5x150 mm  
1202E PH0x60-PH1x80-PH2x100 mm  
1201EN 4x30 mm  
1202EN PH1x30 mm



## 1207E/TX-D7

012071207

~~63,50 €~~  
36,00 €

Sada 7 šroubováků Torx®

1207E/TX T6-T8-T10-T15-T20-T25-T30



**Beta** **EVOX**

**THE EVOLUTION OF THE SCREWDRIVER!**

## 1293/D8

012930403

~~97,00 €~~  
43,00 €

Sada 8 šroubováků

1290 0,5x3x75-0,8x4x100-1x5,5x150-1,2x6,5x150-1,2x8x150 mm  
1292 PH0x3x60 -PH1x4,5x80-PH2x6x100 mm



**Beta** **max**  
MAXIMUM PERFORMANCE

1290 1x5,5x150

**Beta**

## 1243/D7

012430017

~~116,50 €~~  
67,00 €

Set of 7 screwdrivers with steel heads

1241 5,5x100-6,5x125-1,2x150-1,6x200 mm  
1242 PH1x100-PH2x100-PH3x150 mm





**900/C11**

009000971

254,00 €  
**146,00 €**

11 hexagon sockets,  
20 bits and 8 accessories,  
in metal case

1/4" 1/4"



1,2 kg

350x150x50 mm

	<b>861LP</b>	●	0,5x3-0,8x5,5-1x5,5-1,2x6,5 mm
	<b>861PE</b>	○	3-4-5-6-8 mm
	<b>861PH</b>	⊕	PH0-PH1-PH2-PH3
	<b>861TX</b>	⊗	T8-T10-T15-T20-T25-T30-T40
	<b>895/1</b>	○	1/4" - 1/4"
	<b>900</b>	○	5-5,5-6-7-8-9-10-11-12-13-14 mm
	<b>900/16</b>	□	1/4" - 3/8"
	<b>900/20</b>		50 mm
	<b>900/21</b>		150 mm
	<b>900/25</b>		
	<b>900/42</b>		
	<b>900BG/30</b>		
	<b>900/55</b>	⊗	

**902A/C22**

009020807

408,00 €  
**232,00 €**

Assortment of 22 hexagon sockets  
and 6 accessories, in metal case

1/2" 1/4"

1/4"		<b>900</b>	○	5-5,5-6-7-8-9-10-11-12-13 mm
		<b>900/20</b>		50 mm
		<b>900/25</b>		
1/2"		<b>900/55</b>	⊗	
		<b>920A</b>	○	10-13-14-15-17-18-19-22-24 27-30-32 mm
		<b>920/21</b>		125 mm
		<b>920/25</b>		
		<b>920/55</b>	⊗	



420x185x60 mm

3,5 kg

**920A/C17M**

009200924

364,00 €  
**208,00 €**

Assortment of 17 hexagon sockets  
and 5 accessories in foam tray, in metal case

1/2"



420x185x60 mm

	<b>920A</b>	○	10-11-12-13-14-15-16-17-18-19-20-21-22-24 27-30-32 mm
	<b>920/21</b>		125 mm
	<b>920/22</b>		255 mm
	<b>920/25</b>		
	<b>920/42</b>		305 mm
	<b>920/55</b>	⊗	

**928A/C12**

009280955

962,00 €  
**549,00 €**

Assortment of 12 hexagon hand sockets  
and 5 accessories, in metal case

3/4"



530x220x80 mm

	<b>928A</b>	○	22-24-27-30-32-34-36-38-41-46-50-55 mm
	<b>928/21</b>		200 mm
	<b>928/22</b>		380 mm
	<b>928/25</b>		
	<b>928/42</b>		450 mm
	<b>928/55</b>	⊗	

# BETA'S RANGE OF RATCHETS

# NEW NEW DESIGN

**INNOVATIVE  
MATERIALS  
FOR TOP  
PERFORMANCE**

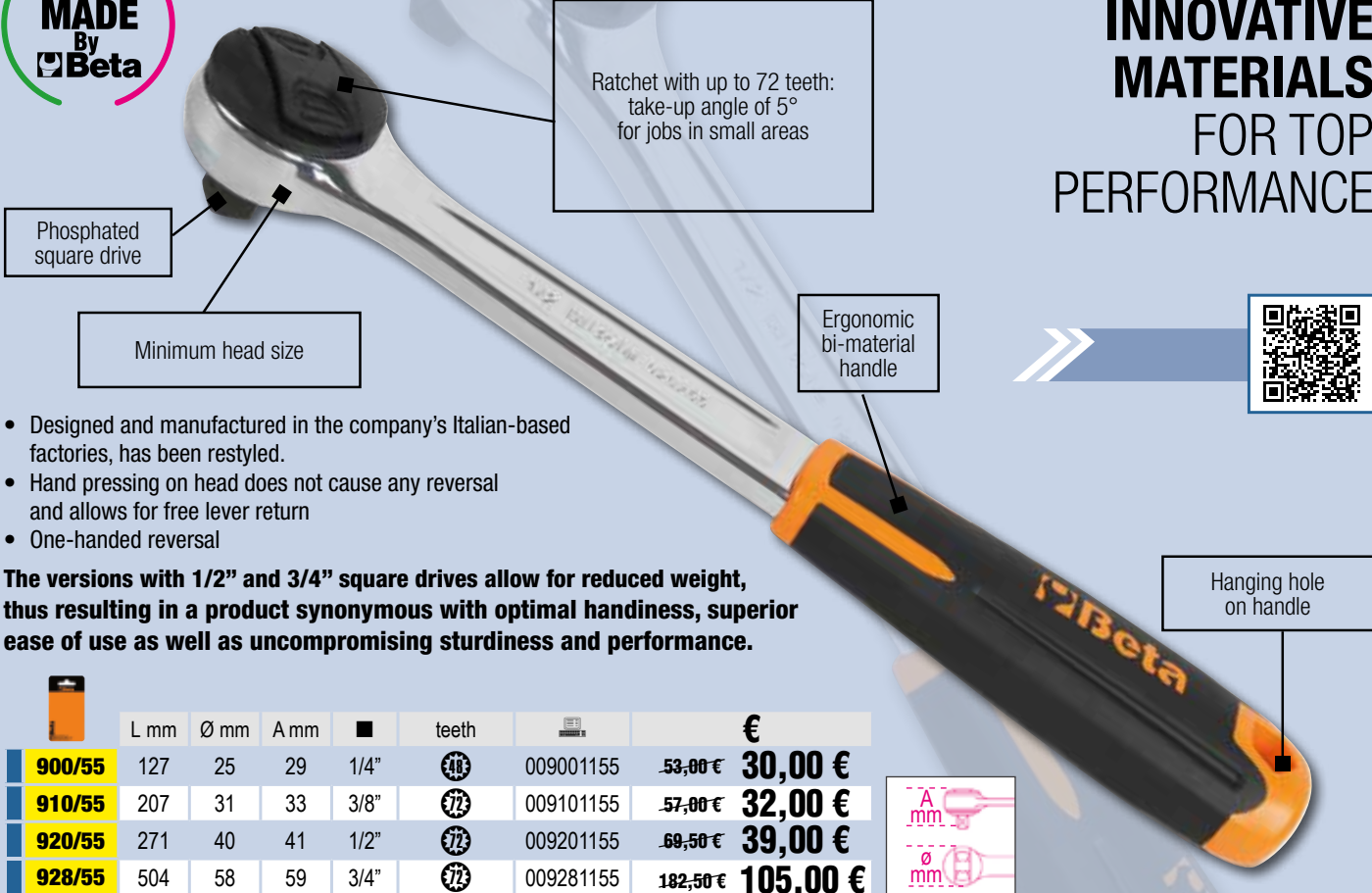

- Designed and manufactured in the company's Italian-based factories, has been restyled.
- Hand pressing on head does not cause any reversal and allows for free lever return
- One-handed reversal

The versions with 1/2" and 3/4" square drives allow for reduced weight, thus resulting in a product synonymous with optimal handiness, superior ease of use as well as uncompromising sturdiness and performance.

	L mm	Ø mm	A mm	■	teeth		€
	127	25	29	1/4"		009001155	53,00 € <b>30,00 €</b>
	207	31	33	3/8"		009101155	57,00 € <b>32,00 €</b>
	271	40	41	1/2"		009201155	69,50 € <b>39,00 €</b>
	504	58	59	3/4"		009281155	182,50 € <b>105,00 €</b>

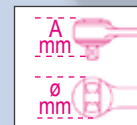

## 867/C52

008670901

52 hexagon bits, 10 mm and 2 accessories

52x



250x170x70 mm

2,1 kg



157,50 €  
**87,00 €**

	867PE	○	4-5-6-7-8-10-12 mm
	867PE/L	○	4-5-6-7-8-10-12 mm
	867XZN	○	M5-M6-M8-M10-M12
	867XZN/L	○	M5-M6-M8-M10-M12
	867TX	⊗	T20-T25-T30-T40-T45-T50-T55
	867TX/L	⊗	T20-T25-T30-T40-T45-T50-T55
	867RTX	⊗	T20-T25-T30-T40-T45-T50-T55
	867RTX/L	⊗	T20-T25-T30-T40-T45-T50-T55
	867/1	○ □	10 mm - 3/8"
	867/2	○ □	10 mm - 1/2"

## 920TX/SB9

009200532

Set of 9 socket drivers for Torx® head screws on support

T20-T25-T27-T30-T40-T45-T50-T55-T60



197,50 €  
**109,00 €**



NEW

599DGT-AW

Electronic torque wrench, torque and angle readout, with reversible ratchet and wireless data transmission, right-hand (accuracy: ± 2%) and left-hand (accuracy: ± 3%) tightening

- Tightening types: torque, angle, torque + angle
- Dual measurement mode: peak hold and track
- Light indicators, an intermittent sound and tactile feedback inform user that preset torque or angle has been reached
- Last 999 peak torque and/or angle readings can be stored and displayed
- 9 "Preset" modes can be saved and preset
- Key safety lockout
- Wrench can be associated with a certain user via software
- Tightening data traceability. Software allows date and time, tool serial number, set tightening value and reached value to be stored and associated with user ID
- Non-slip bi-material handle
- Wrench + software in 9 languages
- Included: 3 AA - 1.5V batteries, wireless USB key and software USB key



UNI EN ISO 6789



14"

38"

12"

599DGT-AW/30

005990702

1.166,00 €

675,00 €

Nm	Kgfm	lbf.ft	■	L (mm)	□
6÷30	0,6÷3	4,5÷22	1/4"	410	0,1

599DGT-AW/135

005990713

1.188,00 €

685,00 €

Nm	Kgfm	lbf.ft	■	L (mm)	□
27÷135	2,7÷13,5	20÷100	3/8"	445	1,0

599DGT-AW/340

005990734

1.265,00 €

719,00 €

Nm	Kgfm	lbf.ft	■	L (mm)	□
68÷340	6,8÷34	50÷250	1/2"	615	1,0



- Bi-directional wireless data transmission, from wrench to software and vice versa, in mass a posteriori or in real time



TORQUE + ANGLE

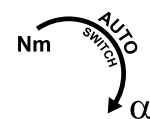

- Customized data processing software with immediate, easy-to-read OK/NG result and real time display of charts

610/5

006100025

207,00 €

118,00 €

Click-type torque wrenches with reversible ratchets, for right-hand tightening, with 5 preset values, torque accuracy: ± 4%

- Selectable torque values: 90 - 100 - 110 - 120 - 130 Nm
- Pull handle end to unlock wrench and select required tightening torque
- When not in use, set torque to lowest value of torque wrench range



UNI EN ISO 6789

L mm	A mm
490	39

610L

Click-type torque wrenches with L-shaped levers, for right-hand tightening, with 5 preset values, torque accuracy: ± 4%



UNI EN ISO 6789

L mm	L1 mm
470	80

610L/5

006100125

183,50 €  
105,00 €

Selectable torque values:  
90 - 100 - 110 - 120 - 130 Nm

610L/5L

006100150

189,00 €  
109,00 €

Selectable torque values:  
120 - 140 - 160 - 180 - 200 Nm



# 666

## TORQUE WRENCH ZERO-RESET THE TORQUE WRENCH THAT DOES NOT REQUIRE RELEASING TENSION

ZERO-RESET click-type torque wrenches with reversible ratchets, for right-hand tightening, torque accuracy:  $\pm 3\%$

UNI EN ISO 6789 **1/4" 3/8" 1/2"**



	Nm	■		L (mm)	g	📄	€
<b>666/2</b>	5÷25	1/4"	0,05	273	395	006660702	<del>303,00 €</del> <b>174,00 €</b>
<b>666/2X</b>	5÷25	3/8"	0,05	273	405	006660703	<del>303,00 €</del> <b>174,00 €</b>
<b>666/5</b>	10÷50	3/8"	0,25	342	680	006660705	<del>275,00 €</del> <b>157,00 €</b>
<b>666/10</b>	20÷100	3/8"	0,25	385	760	006660710	<del>277,00 €</del> <b>158,00 €</b>
<b>666/10X</b>	20÷100	1/2"	0,25	385	770	006660711	<del>283,00 €</del> <b>162,00 €</b>
<b>666/20</b>	40÷200	1/2"	0,5	471	1020	006660720	<del>301,00 €</del> <b>171,00 €</b>
<b>666/30</b>	60÷300	1/2"	1	600	1271	006660730	<del>342,00 €</del> <b>196,00 €</b>



# 667

ZERO-RESET click-type torque wrenches with push-through ratchets, for right-/left-hand tightening, torque accuracy:  $\pm 3\%$

UNI EN ISO 6789 **1/2" 3/4"**



	Nm	■		L (mm)	g	📄	€
<b>667/20</b>	40÷200	1/2"	0,5	471	1035	006670720	<del>296,00 €</del> <b>168,00 €</b>
<b>667/30</b>	60÷300	1/2"	1,0	600	1285	006670730	<del>330,00 €</del> <b>186,00 €</b>
<b>667/40</b>	80÷400	3/4"	1,0	710	2220	006670740	<del>793,00 €</del> <b>450,00 €</b>

# 677/C

Break-back torque wrenches with push-through ratchets, for right-hand and left-hand tightening, torque accuracy:  $\pm 4\%$  in case

**677/C800** UNI EN ISO 6789 **3/4"**



The break-back torque wrench, Beta 677, is particularly suitable for heavy-duty use at high torques. The break-back mechanism informs the user that the set torque has been reached through the bending of the wrench at the joint by approximately 20°.



- Wrench composed of two parts: lever with ratchet and break-back system with torque adjustment



	Nm	kgfm	lbf.ft	■		L (mm)	kg	📄	€
<b>677/C600</b>	120÷600	12÷60	100÷450	3/4"	10	1059	6,0	006770607	<del>1.218,00 €</del> <b>699,00 €</b>
<b>677/C800</b>	200÷800	20÷80	150÷600	3/4"	10	1319	6,7	006770612	<del>1.268,00 €</del> <b>725,00 €</b>
<b>677/C1000</b>	300÷1000	30÷100	200÷750	3/4"	20	1554	7,4	006770616	<del>1.335,00 €</del> <b>769,00 €</b>

**601C**

006010100

~~247,00 €~~  
**143,00 €**

**Digital angle indicator**

- For tightening screws to values set by measuring torsion angle
- Complete with buzzer and LED indicators informing user that preset angle has almost or finally been reached
- For right-hand and left-hand tightening
- Angle accuracy: +/- 2°
- Resolution: 0.1°
- Up to 9 angle values can be preset
- Up to 50 measurements can be stored
- Supplied in an ABS case
- Power supply: 2 AAA-size batteries (included)



**601CA**

006010120

~~437,00 €~~  
**253,00 €**

**Digital torque and angle indicator**



- Allows torque and angle tightening
- For right-hand and left-hand tightening
- Torque accuracy: +/- 4% of set value - Angle accuracy: +/- 2°
- Reading scale in Nm/ft.lb/in-lb/kg.cm/degrees
- Complete with buzzer and LED indicators informing use that preset angle or torque has almost or finally been reached
- Up to 9 torque or angle values can be preset
- Up to 50 measurements can be stored
- Power supply: 2 AAA-sized batteries (included)

<input type="checkbox"/>	<input checked="" type="checkbox"/>	Nm	
1/2"	1/2"	40÷200	0,1



**1009L/DP-S2**

010090060

~~88,00 €~~  
**51,00 €**

**Set of 2 extra-long, knurled double swivel nose pliers**

**L 340 mm**



45°



1009L/DP

1009L/D

**1031/S4**

010310000

~~129,50 €~~  
**73,00 €**

**Set of 4 circlip pliers**

1032 180 mm  
○ 19 ÷ 60 mm



1038 175 mm  
● 19 ÷ 60 mm



1036 175 mm  
● 19 ÷ 60 mm

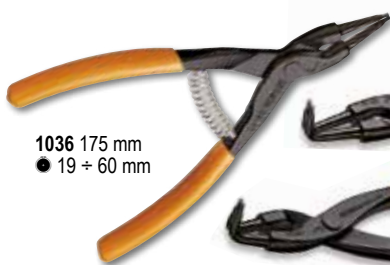

1034 170 mm  
○ 19 ÷ 60 mm



**1169GBM/D2**

011690272

~~69,00 €~~  
**39,00 €**

**Set of 1 combination pliers and 1 diagonal cutting nippers, bi-material handles, industrial finishing**



1082GBM  
160 mm



1150GBM  
180 mm



**1169BM/D3**

011690133

~~113,50 €~~  
**65,00 €**

**Set of 1 combination pliers, 1 long needle nose pliers and 1 diagonal cutting nippers**



1166BM 160 mm

1150BM 180 mm

1082BM 160 mm



**PATENTED**

**ABSOLUTELY  
GROUNDBREAKING  
REMARKABLE CUTTING CAPACITY**

**1150HPC**

011500618

~~76,00 €~~  
**42,00 €**



**Heavy duty universal pliers  
with cutting edges made  
of sintered steel**

- The decentralized pin allows the fulcrum to be closer to the cutting point, thereby resulting in an improved lever effect.
- Perfect alignment of the nose and the thin profile allow the pliers to be used in very small areas.
- The body of the pliers is made of a reliable molybdenum steel which has been heat treated in order to be flexible and resistant so as to guarantee a safe grip in any moment.



Shearing stress - static test = **-73%**

Average life of cutting edges = (test ISO 5744) **+127%**

Hardness of M2 steel cutting edges = **65HRC**



**437U/09**

004370550

~~396,00 €~~  
**228,00 €**

**Assortment for repairing  
damaged threads  
in metal case**

- M5X0,8
- M6X1,0
- M8X1,25
- M10X1,5
- M12X1,75

370x230x55 mm



**1430/S5**

014300105

~~29,50 €~~  
**17,00 €**

**Set of 5 tapered extractors for broken  
screws and studs,  
made from hardened steel,  
in case**

1430/1-1430/2-1430/3  
1430/4-1430/5

110x150x40 mm



**446/C110**

004460060

~~1.016,00 €~~  
**549,00 €**

**Assortment of 105 chrome-steel taps  
and dies, metric thread,  
and 5 accessories for car repair jobs,  
in wooden case**

- 435/0 444/1 436/1
- 435/3 444/2



500x337x60 mm

I	II	III	IV
430 M mm	433 M mm	440/440A M mm	441/441A M mm
2x0,4	6x0,75 - 7x0,75	2x0,4	6x0,75 - 7x0,75
3x0,5	8x0,75 - 8x1	3x0,5	8x0,75 - 8x1
4x0,7	9x0,75 - 9x1	4x0,7	9x0,75 - 9x1
5x0,8	10x0,75 - 10x1	5x0,8	10x0,75 - 10x1
6x1	10x1,25 - 11x0,75	6x1	10x1,25 - 11x0,75
7x1	11x1 - 11x1,25	7x1	11x1 - 11x1,25
8x1,25	12x0,75 - 12x1	8x1,25	12x0,75 - 12x1
9x1,25	12x1,25 - 12x1,5	9x1,25	12x1,25 - 12x1,5
10x1,5	14x1 - 14x1,25	10x1,5	14x1 - 14x1,25
11x1,5	14x1,5 - 16x1	11x1,5	14x1,5 - 16x1
12x1,75	16x1,5 - 18x1,5	12x1,75	16x1,5 - 18x1,5
14x2		14x2	
16x2		16x2	



## 1545/C5M

015450011

644,00 €  
**365,00 €**

### Puller 1542/1 with 5 extractors 1544

	A mm	C mm
1544/1	9+12	0,80
1544/2	13+17	1,15
1544/3	16+21	1,70
1544/4	20+25	1,65
1544/5	25+30	2,00

265x180x45 mm

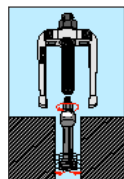

## 1547/C6

015470006

331,00 €  
**186,00 €**

### Dummy ball bearing extractors

Bearings:  
1547/1 6011-6014, 6206-6211, 6303-6308, 6403-6405  
1547/2 6004-6010, 6200-6205, 6300-6304



420x185x60 mm



## 1500

### Two-leg universal pullers

- For both external and internal use
- Legs can be moved along crosspiece with stop nuts

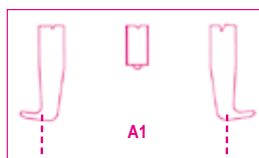

	A min÷max mm	L mm	L1 mm	● mm	A1 min÷max mm		€
<b>1500/1</b>	25÷80	100	135	17	70÷130	015000301	<del>98,50 €</del> <b>57,00 €</b>
<b>1500/2</b>	25÷130	100	135	17	80÷180	015000302	<del>103,00 €</del> <b>59,00 €</b>
<b>1500/3</b>	50÷160	150	210	22	105÷220	015000303	<del>171,00 €</del> <b>99,00 €</b>
<b>1500/4</b>	60÷200	150	210	22	120÷270	015000304	<del>235,00 €</del> <b>136,00 €</b>
<b>1500/5</b>	80÷250	205	280	27	160÷330	015000305	<del>427,00 €</del> <b>248,00 €</b>
<b>1500/6</b>	80÷320	205	280	27	160÷420	015000306	<del>501,00 €</del> <b>290,00 €</b>
<b>1500/7</b>	110÷520	205	280	27	195÷600	015000307	<del>749,00 €</del> <b>435,00 €</b>
<b>1500/8</b>	170÷640	230	310	36	260÷715	015000308	<del>1.199,00 €</del> <b>693,00 €</b>



## 1517C

### Combination two/three-leg self-locking pullers

- Leg holder with configuration for 2- or 3-leg use.
- Simultaneous leg opening.
- Self-locking effect.
- With shear pin.
- Size 2 with screw extension (total length of screw with extension: 360 mm)

	A min÷max mm	L mm	L1 mm	● mm		€
<b>1517C/0</b>	12÷140	145	250	18	015170500	<del>269,00 €</del> <b>143,00 €</b>
<b>1517C/1</b>	20÷180	200	300	18	015170501	<del>319,00 €</del> <b>176,00 €</b>
<b>1517C/2</b>	30÷280	270	300	18	015170502	<del>396,00 €</del> <b>209,00 €</b>



## 31/SP6

000310030

~~91,50 €~~  
**53,00 €**

**Set of 6 pin pinches with support**

2-3-4-5-6-8 mm



## 963

009630001

~~43,00 €~~  
**24,00 €**

**Pry bar with pointed and flat bent ends**

400 mm



## 965 450

009650014

~~28,00 €~~  
**16,00 €**

**Pry bars with flat curved ends**

450 mm



## 1370

**Engineers's hammers wooden shaft**

**HICKORY**



UNI 7778 DIN 1041

	g	g		€
<b>1370/300</b>	300	439	013700053	<del>17,90 €</del> <b>10,00 €</b>
<b>1370/500</b>	500	669	013700055	<del>21,90 €</del> <b>13,00 €</b>
<b>1370/800</b>	800	949	013700058	<del>28,50 €</del> <b>17,00 €</b>
<b>1370/1000</b>	1000	1180	013700060	<del>34,00 €</del> <b>20,00 €</b>
<b>1370/1500</b>	1500	1722	013700065	<del>39,00 €</del> <b>23,00 €</b>
<b>1370/2000</b>	2000	2181	013700070	<del>46,00 €</del> <b>27,00 €</b>

## 1390

**Soft face hammers, wooden shaft**



UNI 7784

	Ø mm	g		€
<b>1390/22</b>	22	134	013900022	<del>21,90 €</del> <b>13,00 €</b>
<b>1390/28</b>	28	230	013900028	<del>27,00 €</del> <b>16,00 €</b>
<b>1390/35</b>	35	365	013900035	<del>37,00 €</del> <b>21,00 €</b>
<b>1390/45</b>	45	689	013900045	<del>59,00 €</del> <b>34,00 €</b>
<b>1390/60</b>	60	1462	013900060	<del>99,50 €</del> <b>58,00 €</b>

## 1599F

**Parallel bench vices, forged**

Fully steel cast.

- Milled and hardened jaw surface
- Front opening
- High clamping depth



	L mm	BxH mm	Ø mm	A max mm		€
<b>1599F/100</b>	100	92x46	11	125	015990100	<del>380,00 €</del> <b>219,00 €</b>
<b>1599F/125</b>	125	108x54	13	150	015990125	<del>485,00 €</del> <b>274,00 €</b>
<b>1599F/150</b>	150	125x62	13	200	015990150	<del>681,00 €</del> <b>384,00 €</b>
<b>1599F/175</b>	175	140x70	15	220	015990175	<del>930,00 €</del> <b>527,00 €</b>

## 1128BMX

011280051

~~20,80 €~~  
**12,00 €**

**Electrician's scissors, straight stainless steel blades, with microteeth**

- Straight stainless steel blades
- Wire cutting groove
- Microteeth on one side



## 1712TFS

017120595

**Telescopic magnet with flexible head**

- Length from 135 mm to 570 mm



Ø 5 mm

**NEW**

~~20,90 €~~

**12,00 €**

## 1750KG10

017500100

**Lever-operated grease gun, 10 kg, with high-pressure hose, 2 m**

3 different pressure levels available:

- 4 g at 275 bar
- 7 g at 206 bar
- 9 g at 137 bar



~~225,00 €~~

**130,00 €**

## 1750

017500500

**Lever operated grease guns, 500 cc**

**550 BAR**



~~50,00 €~~

**29,00 €**

## 1650

**Sliding gauge made from hardened stainless steel**

- Reading to 0.05 mm
- Spring locking

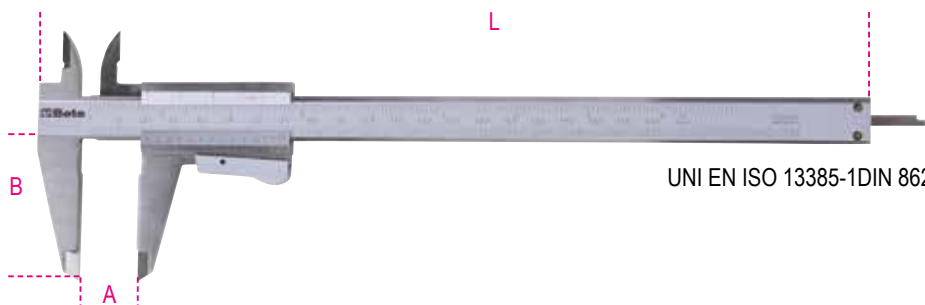

UNI EN ISO 13385-1DIN 862

	A max mm	L mm	B mm	G mm	HxS mm	g	017600001	€	€
<b>1650 150</b>	12÷140	145	250	18	16x3	170	016500001	<del>71,00 €</del>	<b>41,00 €</b>
<b>1650 200</b>	20÷180	200	300	18	-	230	016500002	<del>93,50 €</del>	<b>54,00 €</b>

## 1760TMC

017600710

**Infrared thermal camera**

Compact thermal camera for contactless temperature measurement, suitable for applications in building, mechanical, electric installation and heating industries.



**TEMPERATURE RANGE FROM -20 ÷ +600 °C**



IP54

- LCD TFT display, 2", 240x320
- Sensor, 32x32 pixels
- Acquisition frequency 7Hz
- Thermal sensitivity <347mK
- Automatic acquisition of hot and cold spots
- Camera for acquisition of images in BMP format (max. 100 images)
- Adjustable emissivity
- Power supply: 3 alkaline AAA batteries
- USB interface
- IP54
- Temperature range: -20 °C ÷ +600 °C
- Infrared band: 6.5÷14µm
- Visible/infrared image fusion: 0.5; 1; 2m
- Alarm function, selecting acceptable maximum and minimum temperatures



9710

**LUBRIBETA UNIVERSAL**

**7-in-1 multipurpose unlocking lubricant**

1. Unlocking
2. Lubricating
3. Detergent, degreasing
4. Rust protective
5. Deoxidizing
6. Waterproof
7. Antifreezing

		€
9710 (1)	097100040	
9710 (2)	097101040	<del>10,30 €</del> <b>6,90 €</b>

400 ml



9740

**BRAKE CLEANER**

**Brake cleaner**

- Ideal for cleaning brake discs and pads, engines.
- Allows any grease and tar deposits to be removed, without leaving residue.
- Also suitable as a general degreaser for metal surfaces.
- Evaporates quickly. Does not damage plastics and rubber.

		€
9740 (1)	097400050	
9740 (2)	097401050	<del>7,35 €</del> <b>4,90 €</b>

500 ml



9841N

098410120

~~31,00 €~~  
**16,00 €**

**BLACK SEAL**

**Black acetic-reticulation silicone sealant, resistant to high temperatures, with convenient pressure dispenser (pressure pack)**

- Withstands temperatures up to 240 °C
- Enables permanent elastic sealing
- Replaces preformed gaskets.
- The convenient dispenser allows easy (one-coated), accurate, uniform spreading of the product

200 ml



**WITHSTANDS TEMPERATURES UP TO 240 °C**

9712

**ULTRA SBLOCK**  
**Unlocking lubricant, super-penetrating**

- Unlocking, deoxidizing, highly penetrating, for quick rust and oxidation removal from nuts, bolts, screws and gears.
- Waterproof, for water and humidity removal from treated parts.
- Highly resistant to cold and heat (-40 °C ÷ +150 °C)

400 ml



		€
9712 (1)	097120040	
9712 (2)	097121040	<del>7,55 €</del> <b>5,00 €</b>

9742

**CONTACT CLEANER**  
**Cleaner for electric and electronic contacts**

- Useful for cleaning and cleansing electronic contacts, circuits and electrical components in general
- Its non-thick consistency allows uniform, quick distribution on treated surfaces, removing grease and dirt, without leaving oily residue
- Evaporates quickly
- Does not damage plastics and rubber

400 ml



		€
9742 (1)	097420040	
9742 (2)	097421040	<del>8,10 €</del> <b>5,50 €</b>

9745

**CARB CLEANER**  
**Cleaner for carburetors and throttle bodies**

- Specific for interior and exterior cleaning of carburetors, suction ducts and throttle bodies
- Totally removes carbonaceous residue, deposits and impurities
- Evaporates quickly.
- Does not leave oily residue

400 ml



		€
9745 (1)	097450040	
9745 (2)	097451040	<del>10,90 €</del> <b>7,15 €</b>

9746

**CLIMA CLEANER**  
**Air conditioner cleaner**

- Thick foam formulation.
- Suitable for industrial, civil and car air conditioners
- Removes dirt, deposits and odours from ducts
- Leaves a pleasant fragrance
- Supplied with a straw

400 ml



		€
9746 (1)	097460040	
9746 (2)	097461040	<del>13,50 €</del> <b>8,50 €</b>

9720

**MULTI GREASE**  
**Multipurpose grease**

- Particularly useful for lubricating chains, gears and moving metal parts as well as hinges, locks and pivots
- Resistant to friction and weather
- Highly resistant to high temperatures (up to 210 °C)
- Highly adhesive. Does not drip

400 ml



		€
9720 (1)	097200040	
9720 (2)	097201040	<del>8,65 €</del> <b>5,60 €</b>

**1838SLIM** ~~83,00 €~~  
018380221 **46,00 €**

**Rechargeable, articulated slim 3-LED inspection lamp**

- Magnetic base
- Charging time: 2.5h
- Battery life: 2-4h/ spot 3h

**Triple light emission**

- front: 100/200 lumens
- back: 180 lumens
- spot (head): 80 lumens



**1838AM** ~~123,00 €~~  
018380400 **68,00 €**

**Rechargeable LED inspection lamp, with double light emission, articulated, can be rotated 180°, with swivel magnetic base and hook**

**• Double light emission:**

- front: LED COB, 60-700 lumens, can be adjusted with potentiometer spot (head): LED SMD, 120 lumens, ON-OFF switch
- Rechargeable 3.6V 2600mAh Li-ion battery
- With USB-C port
- Supplied with 100-240V / 50-60Hz charger
- Charging time: 4h
- Battery life: front: 2.5-16h spot (head): 10h
- 3-LED battery level indicator
- Magnetic base (with neodymium magnet), can be rotated 90°
- Swivel base hook
- IP54
- IK07



**1838E** ~~210,50 €~~  
018380270 **120,00 €**

**Rechargeable under bonnet LED lamp**

- Triple light emission: 500/1000/2000 lumens
- Can be rotated 360°
- Length range: 116 ÷ 188 cm
- Aluminium body
- Nonslip rubber hooks
- USB-C charge
- Supplied with battery charger
- Input: 100-240V ~ 50/60Hz
- Output: DC 5V - 2000 mA
- IP 20
- IK 07



**2 charging modes:**  
charge via lamp USB port  
charge via internal battery USB port

**1838E-BT** ~~59,50 €~~  
018380271 **34,00 €**

**Rechargeable battery with USB-C port for under bonnet lamp item 1838E**

- Li-Ion 3,6V - DC 5V - 2000 mA

**1838/11LED** ~~188,00 €~~  
018380111 **103,00 €**

**Rechargeable inspection lamp with ultra-high brightness LEDs, lithium polymer battery**

- Compact body made of antislip rubber
- With charging station, 110-230Vac

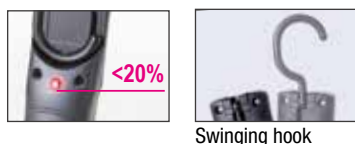

**NEW**  
**1838COMPACT** ~~71,50 €~~  
018380011 **39,00 €**

**Rechargeable, compact LED lamp**

- **Dual light emission:** main and spot
- 3 light intensities:  
main COB LED 300 - 120 lumens  
spot SMD LED 150 lumens
- Rechargeable battery: Li-Ion 3.7 V, 1500 mAh
- Charging time: 2.5h
- Battery life: main: 7/3.5h spot: 6h
- Belt clip/pocket
- IP65; IK07
- USB-C cable included





## 1839W/K1

018390810

292,00 €  
152,00 €

### Kit of wireless lamps 1838SW and 1838POCKET, with compatible charging base 1839BRW

- Wireless rechargeable, articulated LED inspection lamp 1838SW
- Wireless rechargeable, articulated pocket LED spotlight 1838POCKET
- Wireless charging base 1839BRW, compatible with the lamps of the kit



1838POCKET

Save up to  
**140,00 €**

1838SW

1839BRW



## 1838SW

018380142

110,50 €  
64,00 €

### Rechargeable, articulated LED inspection lamp and wireless charging

- Rechargeable 3.6V 3.350mAh Li-ion battery
- 2 charging modes:
  - wireless 1839BRW base
  - power supply with USB-C port
- Charging time:
  - 6.5h with wireless charging base
  - 4.5h with power supply
- Battery life:
  - front: 3-5h
  - spot (head): 7h
- 3-LED battery level indicator
- Base can be rotated 180°
- Nonslip rubber body
- Double swinging hook
- Magnets on base and back
- IP65
- IK07



- Dual light emission:
  - front: LED COB, 3 light intensities: 250 - 500 - 1000 lumens
  - spot (head): LED SMD, 200 lumens



## 1838POCKET

018380080

77,50 €  
45,00 €

### Articulated pocket LED spotlight, with dual light beam and wireless charging

- Rechargeable 3.7V 2600mAh Li-ion battery
- 2 charging modes:
  - wireless 1839BRW base
  - power supply with USB-C port
- Charging time:
  - 4.5 h with wireless charging base
  - 4 h with power supply
- Battery life:
  - main light: 3-9h
  - spot light: 4.5 h
- 3-LED battery level indicator
- Can be rotated 210°
- Nonslip rubber body
- Magnetic base
- 1 magnet on base
- Supplied with a USB-C cable
- IP65
- IK07



- Dual light emission:
  - main light: LED COB, 3 light intensities: 160 - 400 - 800 lumens
  - spot light: LED SMD, 250 lumens
- Lighting angle:
  - main light: 160°
  - spot light: 18°



## 1839BRW

018390002

104,50 €  
61,00 €

### Wireless charging base, compatible with 1838POCKET, 1838SW, 1836AW, 1833MW and 1833XSW inspection lamps

- Two charging positions with magnetic connection, for simultaneous use
- With pull-out support for wireless mobile phone charging
- Charging status LED indicator
- Max. input: 10W x2
- Input: AC 100-240V 50/60Hz
- Output: DC 12V 1.5A  
DC 9V 2A  
DC 5V 3A
- USB-C port
- IP20
- IK07



- Can be hung on wall through: 3 strong magnets on back 2 screw holes





# POWER TOOLS



Let us introduce our range, Beta Power Tools, which comprises reliable, durable work instruments designed to satisfy every professional's requirements.

Beta's family of power tools comprises:

- BATTERY TOOLS
- CORDED TOOLS

The new range of battery tools includes 20V and 12V high-performance machines.

The new range of battery tools includes 20V and 12V high-performance machines. We at Beta relied on these hallmarks

to develop a comprehensive line of battery tools, ranging from the high-torque impact drill to the impact wrench with 1/2" square drive. All of Beta's new power tools are equipped with brushless motors and first-rate interior mechanisms, for significantly improved performance and durability of the tool.

The impact wrench with a maximum unscrewing torque of 1200 Nm is no doubt the flagship power tool of the new range, an ideal work partner for anybody who needs unparalleled power and performance.



## 1972/K12V-10 289,00 € 019720112 153,00 €

### Ultracompact drill, 12V

**Ultracompact:** no more than 170 mm in length; ultralightweight: no more than 1.1 kg, with battery, and perfectly balanced

**Features:**

- Double mechanical speed with steel gears and 20-position clutch
- Torque up to 30 Nm and 1300 rpm (400 rpm in 1st gear); drills diameters up to 10 mm in steel and 20 mm in wood
- 2Ah batteries and charge indicator on drill body
- Ergonomic nonslip handle
- Front LED
- 10-mm autochuck
- Belt clip (right/left side)
- Selector switch, screwing-unscrewing-locking modes (for transportation)
- **Supplied in a hard case with 2 lithium ion batteries (2 Ah) and quick charger (50 min)**



## 1986/K20-4AH+2AH 700,00 € 019860022 318,00 €

### 20V kit of angle grinder + 2 Ah battery



**Composed of:**

- **1986/K20V-125**  
Angle grinder, brushless, 20V, with slide switch, disc diameter 115/125 mm, protection against accidental restart, tool-less disc cover, additional handle.
- **Supplied in a hard case complete with 2 4 Ah batteries and quick charger.**

**INCLUDED IN PRICE**  
additional 2 Ah battery  
1994B 20V-2AH



## 1986/20V-125BMC 259,00 € 019860025 153,00 €

### Angle grinder, 20V BRUSHLESS, (machine body)

Digital BRUSHLESS motor for increased power, reduced energy consumption, extended motor service life, improved power supply from button.

- Protection against accidental restart
- Additional handle, can be placed on both sides
- Tool-less disc cover (quick release)
- Spindle lock device for quick disc changes
- Lock on/off slide switch
- Air vents protected against dust infiltration and providing optimal cooling
- Disc diameter (not included): 125/115 mm
- **Supplied in a hard case, without batteries and charger**





Digital BRUSHLESS motor,  
for significantly improved performance: increased power,  
reduced energy consumption, extended motor service life, improved power supply  
from button.  
**ADDITIONAL SIDE HANDLE,**  
for high-torque operation

**1984/K600-4AH+2AH** 796,00 €  
**406,00 €**  
019840022

- 3 different torque settings and rpms in screwing mode
- Up to **600 Nm** unscrewing torque

**1984/K1200-6AH+4AH** 996,00 €  
**494,00 €**  
019840032

- 3 different torque settings and rpms in screwing mode
- Up to **1200 Nm** unscrewing torque



**THIRD BATTERY  
2 AH INCLUDED  
IN PRICE**



**THIRD BATTERY  
4 AH INCLUDED  
IN PRICE**

**1989RCB**

019890020

374,00 €  
**219,00 €**

**Construction site radio, 20V**

Multifunctional audio entertainment: digital (DAB; BT) and conventional FM radio. Suitable for use at construction sites or for leisure. Sturdy radio with compact, modern, design, degree of protection IP54. Powerful stereo sound provided by two powerful 16W side loudspeakers. Built-in alarm function. Complete with carrying handle and shockpro of corner protection. With AUX connection and protected USB connector for phone connection and charge. **Can be used with Beta's 20V batteries (optional) or power supply cord (included).**



**INCLUDED:**



**Features:**

- FM radio frequency range: 87.5 – 108 MHz
- DAB radio frequency range: 174 – 240 MHz
- Number of FM and DAB stored stations: 30



**1273MQ/D6**

012730851

80,00 €  
47,00 €

**Set of 6 screwdrivers**

1274MQ ● 3x100-4x100-5,5x125 mm  
1272MQ ⊕ PH0x60-PH1x80-PH2x100 mm

EN 60900



△ 1000 V



**NEW**

**1760PT/N**

017600155

132,00 €  
75,00 €

**Voltage and continuity tester, 1000 V**

Voltage and continuity tester: accuracy and reliability with up to 1000V power. Equipped with a high-visibility digital screen and a convenient self-test function, the tool ensures both accuracy and reliability in each measurement, which makes it a must-have for every professional.



**Features**

- Voltage: 24÷1000VAC / 6÷1000VDC
- Bar voltage indicator: 6-12-24-50-120-230-400-690-1000
- Accuracy: ± (3% + 3)V
- Response time: < 1s (09%)
- Maximum absorbed current @1000V: < 3,5mA
- Contact-free voltage detection: > 90VAC
- Phase rotation test: 100÷1000VAC (50/60Hz)
- Phase angle: 120° ±5°
- Continuity test: 0±1.3 MΩ
- Current (continuity test): ≤5 μA
- Pollution level
- Power supply

**NEW**

**1997MQ/GM**

**Composite insulating gloves**

△ 1000 V

EN 60903  
EN 61482



CLASSE 0



	G		€
<b>1997MQ/GM 9</b>	9	019970109	<del>187,00 €</del> <b>105,00 €</b>
<b>1997MQ/GM 10</b>	10	019970110	<del>187,00 €</del> <b>105,00 €</b>

**NEW**

**1760OHM/2**

017600027

429,00 €  
241,00 €

**Megohmmeter for high voltage insulating testing**

Our megohmmeter is synonymous with technology and accuracy for really professional measurements. With an insulating capacity up to 100 GΩ at 1000V voltage, this instrument is ideal for professional, accurate measurements in all electrical applications. Particularly suitable for electric and hybrid cars.



**Features:**

- Insulation test up to 100 GΩ with 1000V voltage
- Large direct reading display, backlight
- Water protection: IP67
- Rubber terminal base for enhanced operating comfort
- Double insulated terminals CAT IV 600V, CAT III 1000V
- Ideal for electric and hybrid cars

	Measuring range	Basic accuracy
AC voltage:	10V - 600V	±(1.5% +5)
DC voltage:	0V - ±600V	±(1.5% +5)
Resistance:	0.01Ω - 200Ω	±(2% +5)
Insulation test @1000V:	0.01Ω - 100GΩ	±(1.5% +5)
Frequency	1~1KHz	±(0.1% +3)

**2115PL-MQ32**

021150332

1.415,00 €  
769,00 €

**Assortment of 32 insulated tools for hybrid cars, in plastic tool box with soft thermoformed tray**

**Quantity/Description**

- 1 1/2" reversible ratchet
- 2 single ring wrenches 10-12 mm
- 1 magnetic bit holder, insulated 1/4"
- 10 set of 10 bits with magnetic bit holder  
⊙ T7-T8-T9-T10-T15-T20-T25-T27-T30-T40
- 7 hexagon sockets ⊙ 8-10-12-13-14-17-19 mm
- 1 1/2" square drive extension bar 125mm
- 1 1/2" square drive extension bar 250mm
- 1 slip joint pliers, boxed joint 250mm
- 1 combination pliers 1000V = 180mm
- 1 extra-long bent flat nose pliers = 160mm
- 2 screwdrivers for cross head Phillips® screws, 1000V ⊕ 4.5X80-6X100mm
- 3 screwdrivers for headless slotted screws, 1000V ● 3X100-4X100-5.5X125
- 1 insulating gloves, made from latex G2
- 1 tool box, long series, made from plastic

- Beta N.**
- 920MQ/55A
  - 89MQ
  - 850MQ
  - 861TX/A10
  - 920MQ/A
  - 920MQ/21
  - 920MQ/22
  - 1048MQ
  - 1150MQ
  - 1164MQ
  - 1272MQ
  - 1274MQ
  - 1997MQ/GM
  - CP15L



△ 1000 V

12"



**2029EM**

020290300

2.445,00 €  
**1.319,00 €**

**Tool case with assortments of 43 maintenance and repair tools for hybrid and electric vehicles**



**3/8"**

**1000 V**

**Quantity/Description**

- 13 single open end wrenches, 1000V  
7-8-9-10-11-12-13-14-15-16-17-19-22 mm
- 7 bi-hex sockets ○ 6-7-10-12-13-17-19 mm
- 3 socket drivers for Torx® head screws  
○ TX25-TX30-TX40
- 1 3/8" drive reversible ratchet
- 1 slip joint pliers, boxed joint 250 mm
- 1 diagonal cutting nippers 1000V  $\leq$  160 mm
- 1 electrician's scissors 145 mm
- 1 combination pliers 1000V  $\equiv$  180 mm
- 1 extra long flat nose pliers  $\equiv$  160 mm
- 2 screwdrivers for cross head Phillips® screws, 1000V  
⊕ PH1 - PH2
- 5 screwdrivers for headless slotted screws, 1000V  
● 2,5x75 - 3x100 - 4x100 - 5,5x125 - 6,5x150 mm
- 1 combination voltage and continuity tester
- 1 cable stripping knife, insulated 190 mm
- 1 composite insulating gloves GM 10
- 2 aluminium warning signs A1 - A2
- 2 prohibition signs D2 - D3

**Beta N.**

- 52MQ
- 910MQ/B
- 910MQ/TX
- 910MQ/55
- 1048MQ
- 1082MQ
- 1128MQ
- 1150MQ
- 1162MQ
- 1272MQ
- 1274MQ
- 1760PT/N
- 1777MQ/U
- 1997MQ/GM
- 7109A
- 7109D



480x227x408 mm



**2400 RSC24/6-VEM**

024004016

6.280,00 €  
**2.969,00 €**

**Mobile roller cab with 6 drawers and assortment of 81 repair and maintenance tools for hybrid and electric vehicles**

**1000 V**



**RSC24/6-R**



**Quantity/Description**

- 1 insulating mat
- 4 plastic posts with fillable bases
- 1 multimeter/megohmmeter for high voltage insulation testing
- 1 combination voltage and continuity tester, 12-690V AC/DC
- 1 spare leads for digital multimeters and amperometric clamps
- 1 composite insulating gloves
- 1 plastic barrier chain
- 2 aluminium warning signs
- 2 prohibition signs
- 12 single open end wrenches, 1000V 7-8-10-11-12-13-14-15-16-17-19-22 mm
- 12 single ring wrenches 7-8-10-11-12-13-14-15-16-17-19-22 mm
- 4 socket drivers for hexagon screws ○ 4-5-6-8 mm
- 11 bi-hex sockets ○ 7-8-10-11-12-13-14-15-16-17-19 mm
- 6 socket drivers for Torx® head screws ○ T15-T20-T25-T27-T30-T40
- 2 socket drivers with XZN® profile ○ 8-10 mm
- 1 3/8" drive extension 125 mm
- 1 3/8" drive extension 250 mm
- 1 3/8" drive, T-handle
- 1 3/8" drive reversible ratchet
- 1 electrician's scissors
- 1 slip joint pliers, boxed joint 250 mm
- 1 diagonal cutting nippers 1000V  $\leq$  160 mm
- 1 combination pliers 1000V  $\equiv$  180 mm
- 1 extra long flat nose pliers  $\equiv$  160 mm
- 1 extra-long bent flat nose pliers  $\equiv$  160 mm
- 4 screwdrivers for cross head Phillips® screws, 1000V  
⊕ PH0x60 - PH1x80 - PH2x100 - PH3x150 mm
- 4 screwdrivers for headless slotted screws, 1000V  
● 2,5x75 - 3x100 - 4x100 - 5,5x125 mm
- 1 cable stripping knife, insulated

**Beta N.**

- 1995MQ/T
- 7104 90
- 1760/OHM
- 1760PT
- 1760DGT-R3
- 1996MQ/GM
- 7105 6
- 7109A
- 7109D
- 52MQ
- 89MQ
- 910MQ/PE
- 910MQ/B
- 910MQ/TX
- 910MQ/XZN
- 910MQ/21
- 910MQ/22
- 910MQ/T
- 910MQ/55
- 1128MQ
- 1048MQ
- 1082MQ
- 1150MQ
- 1162MQ
- 1164MQ
- 1272MQ
- 1274MQ
- 1777MQ/U

**TR**

**M49**

**M49**

**M108**

**M108**

**M108**

**M108**

**M108**

**M108**

**M108**

**M108**

**M108**

**M161**

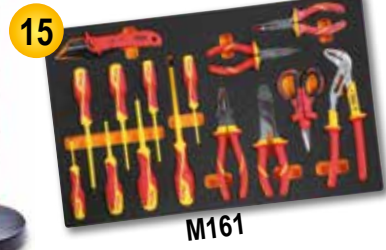
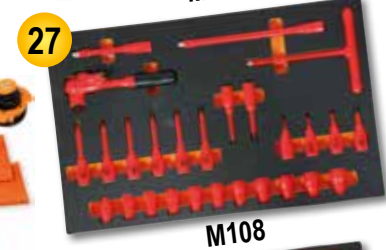
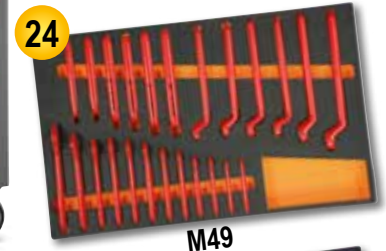

# HOSE REEL



- Automatic hose reel, shockproof plastic body, for air or water
- Max. operating pressure: 15 bar
- Braided polyurethane hose
- Polypropylene frame
- Device for automatically fixing hose at required length
- Rack mechanism can be disabled to keep hose pulled
- Water operating temperature range: -5 °C / +50 °C
- Supplied with a 180° swivel bracket and an additional quick connection bracket

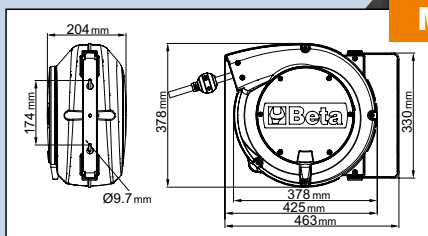
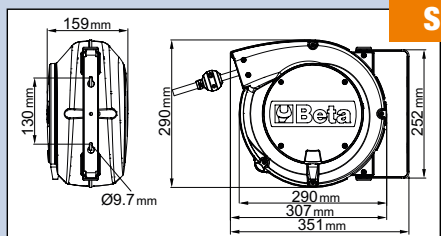

## 1900S 8X10

019000080

195,50 €

**105,00 €**

**Automatic spring hose reel with 8x12 mm cable**

- Cable length 10 m

Ø GAS BSP 1/4"

## 1900M 8X15

019000085

267,00 €

**142,00 €**

**Automatic spring hose reel with 8x12 mm cable**

- Cable length 15 m

Ø GAS BSP 1/4"

## 1900M 10X15

019000115

278,00 €

**153,00 €**

**Automatic spring hose reel with 10x14 mm cable**

- Cable length 15 m

Ø GAS BSP 3/8"

**NEW**

## 1900M 12X15

019000125

363,00 €

**197,00 €**

**Automatic spring hose reel with 12x16 mm cable**

- Cable length 15 m

Ø GAS BSP 1/2"

## 1844 15-H05/SCK

018440316

264,00 €

**153,00 €**

**Automatic cable reel, with 3Gx1.5 mm<sup>2</sup> cable and SCHUKO type socket and plug**

- 3Gx1.5 mm<sup>2</sup> cable
- With thermal protection switch
- Max. power (rolled up): 1500W (230V-20°C)
- Max. power (unrolled): 2500W (230V-20°C)



## BATTERY CHARGERS

# NEW



Since 2022 the established, authoritative welding specialist, Helvi, and Beta Utensili have been working together to develop ground-breaking technologies. This joint effort has translated into the new range of Beta by Helvi welding machines, which boast ultimate performance in line with its high quality standards.

Easy-to-use inverter welding machines with excellent welding characteristics for all types of electrodes. With overvoltage and overtemperature control and electrode anti-sticking function. Compact and lightweight, ideal for home maintenance jobs, light carpentry and maintenance jobs.



### 1498/PR

#### Semiprofessional battery

- For lead-acid storage batteries
- Voltage/current selectors
- Ammeter
- Automatic thermal overload protector
- Reverse polarity protector

#### 1498/PR14

014980730

155,00 €  
89,00 €

Conventional battery charger, 6/12 V

#### 1498/PR17

014980731

171,50 €  
99,00 €

Conventional battery charger, 12/24 V

#### 1498/PR20

014980732

231,00 €  
135,00 €

Conventional battery charger, 12/24 V



#### 1498/PR14 1498/PR17 1498/PR20

	230 V - 50/60 Hz	230 V - 50/60 Hz	230 V - 50/60 Hz
Power supply (1ph)	230 V - 50/60 Hz	230 V - 50/60 Hz	230 V - 50/60 Hz
Power	140 W	300 W	390 W
Voltage	6/12 V	12/24 V	12/24 V
Maximum current	11 A	12,5 A	16 A
Charging current	7,5 A	8,5 A	11 A
Charging capacity	112 Ah 15h	128 Ah 15h	165 Ah 15h
Charging positions	2	2	2



#### 1498/PR25

014980733

461,00 €  
269,00 €

Conventional battery charger,  
6/12/24 V

- For large charging stations
- For lead-acid storage batteries
- Voltage/current selectors
- Ammeter
- Automatic thermal protector

#### 1498/PR35B

014980734

869,00 €  
499,00 €

Conventional battery charger,  
6/12/24/36/48 V

#### 1498/PR25 1498/PR35B

	230 V - 50/60 Hz	230 V - 50/60 Hz
Power supply (1ph)	230 V - 50/60 Hz	230 V - 50/60 Hz
Power	620 W	1830 W
Voltage	6/12/24 V	6/12/24/36/48 V
Maximum current	25 A	38 A
Charging current	17 A	25 A
Charging capacity	255 Ah 15h	375 Ah 15h
Charging positions	6	12



**BATTERY CHARGERS**

**NEW**

**1498/AM30**

014980740

653,00 €  
379,00 €

**Automatic conventional battery charger 12/24 V**

- For AGM, GEL, Lead-Acid and Start/Stop batteries
- Electronic control of charging current
- Charging status light indicators
- Charging current regulation via potentiometer
- Automatic charging function
- Maintenance function



Power supply (1ph)	230 V - 50/60 Hz
Power	720 W
Voltage	12/24 V
Maximum current	30 A
Charging current	20 A
Charging capacity	300 Ah 15h
Charging positions	∞

**1498/SP**

**Conventional battery charger / starter, 12 V**

- For lead-acid storage batteries
- Charging current selector
- Ammeter
- Thermostatic long start protector
- Short-circuit protection fuse
- Reverse polarity protector



**1498/SP150**

014980745

220,00 €  
129,00 €

**Conventional battery charger, 12 V**

**1498/SP250**

014980746

349,00 €  
199,00 €

**Conventional battery charger, 12/24 V**

**1498/SP150 1498/SP250**

	1498/SP150	1498/SP250
Power supply (1ph)	230 V - 50/60 Hz	230 V - 50/60 Hz
Power	190 W	650 W
Voltage	12 V	12/24 V
Maximum current	15 A	27 A
Charging current	11 A	18 A
Max. boost current	120 Acc	200 A
Starting current	85 A	135 A
Charging capacity	165 Ah 15h	270 Ah 15h
Charging positions	2 + boost	2 + boost

**1498/SC**

**Battery charger / starter, 12/24 V, wheeled**

- For lead-acid storage batteries
- Slow/fast charging current selector
- Ammeter
- Thermostatic long start protector
- Short-circuit protection fuse
- Reverse polarity protector



**1498/SC341**

014980755

524,00 €  
299,00 €

**1498/SC540**

014980757

177,00 €  
445,00 €

**1498/SC441**

014980756

570,00 €  
335,00 €

**1498/SC640**

014980758

856,00 €  
499,00 €

**1498/SC341 1498/SC441 1498/SC540 1498/SC640**

	1498/SC341	1498/SC441	1498/SC540	1498/SC640
Power supply (1ph)	230 V - 50/60 Hz	230 V - 50/60 Hz	230 V - 50/60 Hz	230 V - 50/60 Hz
Power	1080 W	1320 W	1440 W	1800 W
Voltage	12/24 V	12/24 V	12 V	12/24 V
Maximum current	45 A	55 A	60 A	75 A
Charging current	30 A	36 A	40 A	50 A
Max. boost current	340 Acc	380 Acc	480 Acc	550 Acc
Charging capacity	375 Ah 15h	450 Ah 15h	525 Ah 15h	600ww Ah 15h
Charging positions	3 + boost	3 + boost	6 + boost	6 + boost

# NEW

## BATTERY CHARGERS

### 1498/RP

**Conventional battery charger / starter, 12/24 V**

- For lead-acid storage batteries
- Charging current selector
- Ammeter
- Thermostatic long start protector
- Short-circuit protection fuse
- Reverse polarity protector



**1498/RP380** ~~461,00 €~~  
014980750 **275,00 €**

**1498/RP480** ~~640,00 €~~  
014980751 **375,00 €**

#### 1498/RP380 1498/RP480

Power supply (1ph)	230 V - 50/60 Hz	230 V - 50/60 Hz
Power	900 W	1320 W
Voltage	12/24 V	12/24 V
Maximum current	38 A	55 A
Charging current	25 A	36 A
Max. boost current	280 Acc	450 A
Starting current	200 A	315 A
Charging capacity	270 Ah 15h	450 Ah 15h
Charging positions	2 + boost	6 + boost

### 1498/AT

**Battery charger / starter, 12 V**

- For lead-acid storage batteries
- Charging current selector
- Ammeter
- Thermostatic long start protector
- Short-circuit protection fuse
- Reverse polarity protector



**1498/AT300** ~~542,00 €~~  
014980760 **319,00 €**

**Battery charger / starter, 12 V**

**1498/AT500** ~~664,00 €~~  
014980761 **359,00 €**

**Battery charger / starter, 12/24 V**

#### 1498/AT300 1498/AT500

Power supply (1ph)	230 V - 50/60 Hz	230 V - 50/60 Hz
Power	300 W	890 W
Voltage	12 V	12/24 V
Maximum current	25 A	37 A
Charging current	20 A	30 A
Max. boost current	300 Acc	450 A
Starting current	210 A	320 A
Charging capacity	375 Ah 15h	540 Ah 15h
Charging positions	2 + boost	6 + boost

**Battery charger / starter, 12/24 V, wheeled**

**1498/AT701** ~~1.063,00 €~~  
014980762 **609,00 €**

**1498/AT1300** ~~2.990,00 €~~  
014980764 **1.715,00 €**

**1498/AT1001** ~~1.745,00 €~~  
014980763 **999,00 €**

**1498/AT2000** ~~4.220,00 €~~  
014980765 **2.419,00 €**



#### 1498/AT701 1498/AT1001 1498/AT1300 1498/AT2000

Power supply (1ph)	230 V - 50/60 Hz	230 V - 50/60 Hz	230 V - 50/60 Hz	230 V - 50/60 Hz
Power	1800 W	2200 W	2900 W	3600 W
Voltage	12/24 V	12/24 V	12/24 V	12/24 V
Maximum current	75 A	90 A	120 A	150 A
Charging current	50 A	60 A	80 A	120 A
Max. boost current	550 Acc	980 A	1280 Acc	2000 A
Starting current	400 A	560 A	850 A	1100 A
Charging capacity	600 Ah 15h	1350 Ah 15h	1800 Ah 15h	2250 Ah 15h
Charging positions	6 + boost	14 + boost	12 + boost	12 + boost

BATTERY CHARGERS

**NEW**

**1498/DG**



**Electronic battery charger / starter, 12/24 V, wheeled**

Equipped with CPS (car protection system) technology, which allows boost function to be activated and deactivated fully automatically, to protect electronics on board vehicle.

- For Lead-Acid, AGM, Gel, Ca/Ca and Start/Stop batteries
- Electronic charge control via microprocessor
- Charging time setting
- Digital display
- Charging status LED indicators
- Control system for: reverse polarity, overcurrent, battery failure indication, safe start, protected start

**1498/DG540E**

014980770

1.049,00 €

**609,00 €**

Battery charger / starter, 12 V

**1498/DG1100E**

014980771

1.390,00 €

**809,00 €**

Battery charger / starter, 12/24 V

**1498/DG540E 1498/DG1100E**

Power supply (1ph)	230 V - 50/60 Hz	230 V - 50/60 Hz
Power	1320 W	2400 W
Voltage	12/24 V	12/24 V
Maximum current	55 A	100 A
Charging current	36 A	70 A
Max. boost current	380 Acc	580 Acc
Starting current	260 A	400 A
Charging capacity	810 Ah 15h	5000 Ah 15h
Charging positions	4 + boost	4 + boost + supply

**1498H**

**Electronic multipurpose battery charger, 6-12V**

Electronic battery chargers 1498H: innovation and technology made to work for professionals! Fitted with LCD displays and 3-colour LED indicators, they can be used with all types of batteries, both lead-acid and lithium. The electronic control card provides full protection against unexpected events. The 9 automatic charging steps ensure fast, efficient charging, with recovery and desulphation features.

- LCD display
- 3-light intensity LED
- Charging and charge maintenance
- Protection against reverse polarity, short-circuits, overheating, overloading, overtemperature
- Spark protection
- 9 charging steps
- Floating system
- Functions: battery recovery, battery test and desulphation
- Clamp holder
- Reclining fixing hook
- Supplied accessories: cable with clamps, cable with eyelets



**1498H/4A**

014980204

176,00 €

**99,00 €**

Electronic multipurpose battery charger, 6-12 V

**1498H/16A**

014980216

319,00 €

**182,00 €**

Electronic multipurpose battery charger, 12-24 V

**1498H/8A**

014980208

216,50 €

**119,00 €**

Electronic multipurpose battery charger, 12/24 V

**1498H/25A**

014980225

341,00 €

**193,00 €**

Electronic multipurpose battery charger, 12/24 V



**1498H/4A**

**1498H/8A**

**1498H/16A**

**1498H/25A**

Power supply (1ph)	230 V - 50/60 Hz	230 V - 50/60 Hz	230 V - 50/60 Hz	230 V - 50/60 Hz
Charging current	1-4 A	2-8 A	4-16 A	6-24 A
Battery types	Pb - GEL - Ca/Ca - AGM - Start/Stop - Lithium (LiFePo4)			
Charging capacity	5-80Ah (LiFePO4 1-80Ah)	10-160Ah (LiFePO4 2-160Ah)	20-360Ah (LiFePO4 4-360Ah)	30-550Ah (LiFePO4 6-550Ah)
Maintenance capacity	5-120Ah (LiFePO4 1-120Ah)	10-250Ah (LiFePO4 2-250Ah)	20-550Ah (LiFePO4 4-550Ah)	30-800Ah (LiFePO4 6-800Ah)
Power supply (DC)	N/A	13.8V - 5A	13.8V - 12A	13.8V - 20A
Output voltage	6-12V	12-24V	12-24V	12-24V
Degree of protection	IP65		IP20	



### 1498BC/12

014980040

385,00 €  
219,00 €

#### Multipurpose portable starter, 12V

- Device protecting against polarity reversal, short-circuit, overcurrent, overcharge and overheating

#### Supplied with:

- Protective case
- Cable with starting clamps
- USB ports for charging electronic devices
- LED battery charge indicator
- USB and USB-C cable
- Mains power supply
- Multifunction LED torch

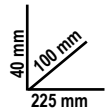

Starting current	600A
Pickup current	1500A
Battery type	4 cells LifePo4
Battery capacity	25000mAh

#### Portable high-performance starter, ultralightweight

The microprocessor provides full protection against:

- Polarity reversal
- Short circuits
- Incorrect voltage
- Overloads
- Underdischarge
- Overcharge
- Overtemperature

12-24V



12V



### 1498LT/12-24

014980014

1.945,00 €  
1.099,00 €

Portable high-performance starter, 12-24 V, ultralightweight, suitable for use on cars, commercial vehicles and trucks.



### 1498LT/12

014980012

980,00 €  
549,00 €

Latest-generation battery LifePo4. Includes memory saver. Weighs no more than 2.5 kg.



#### 1498LT/12 1498LT/12-24

Operating voltage	12V	12/24V
Continuous amperage	800 A	2000/1000 A
Maximum starting amperage	2000 A	5000/2500 A
Peak amperage	4000 A	10000/5000 A
Cable	1000 A	1000 A
Cable length	500 mm	1600 mm
Battery type	4 celle LifePo4	4 celle LifePo4
Memory saving function	YES	YES
Dimensions	260x135x72 mm	350x240x140 mm

**NEW**
**1498EL/12**

014980712

~~567,00 €~~  
**318,00 €**
**Portable starter, 12V**

- Pickup current: 1800A
- Battery capacity: 22 Ah

**NEW**
**1498EL/12-24**

014980724

~~1.089,00 €~~  
**599,00 €**
**Portable starter, 12/24V**

- Pickup current: 3600A 12V - 1800A 24V
- Battery capacity: 2x 22 Ah

**NEW**
**1498TB/12-24N**

014980402

~~407,00 €~~  
**235,00 €**
**Digital battery tester, 12-24V, with built-in printer**

- allows the following to be tested: battery, alternator, starter and system
- reverse polarity protector
- Fitted with software for connecting instrument to PC
- Backlit display
- Compact, shockproof frame
- 9 language software

**Technical data:**

- Applications: 12V and 24V batteries
- Operating range: 100-2000 CCA
- Reference standards: CCA, SAE, DIN, EN, IEC, JIS, MCA, GB, BCI, CA
- Supported batteries: PB, WET, GEL, AGM, AGM FLAT, EFB, SLI
- Voltmeter: 9V-30V
- Cable length: 1800 mm
- Supported languages: Italian, English, French, German, Spanish, Polish, Dutch, Hungarian, Portuguese
- Included accessories: USB cable, 3 printer paper rolls

**1497/C94**

014970300

~~463,00 €~~  
**263,00 €**
**Assortment of 94 car testing connectors for use with main diagnostic tools**

- 2 t-taps
- 2 potentiometers
- 2 warning lights
- 2 SRS connectors
- 2 alligator clips
- 2 acicular probes
- 2 prods
- 2 dual banana connectors
- 4 single banana connectors
- 24 flat male terminals 0.6÷6 mm
- 12 round male terminals 1.6÷3.9 mm
- 24 flat female terminals 0.6÷6 mm
- 12 round female terminals 1.6÷3.9 mm



430x390x100 mm

**1497/C23**

014970200

263,00 €  
**153,00 €**

**Assortment of 23 tools for releasing electrical connectors**



440x250x70 mm

**1760DGT/2**

017600008

875,00 €  
**494,00 €**

**Digital automotive multimeter, portable, with 2-channel oscilloscope and waveform generator**



**Kit Contents:**

- Multimeter tips
- 2 BNC crocodile clips for oscilloscope
- Tip probe for oscilloscope (1X and 10X)
- Battery charger
- Nylon sheath

Max. voltage	600V DC
Max. current	10A DC
Max. resistance	40MOHM
Max. capacity	100uF
Display	2.8" colour TFT
Resolution	320 x 240 pixels
Power supply	100V-240V AC, 50Hz-60Hz; DC INPUT 5V DC-2A
Battery	2 x 2600 mAh



**Technical data:**

- Display: 2.8" colour TFT
- Resolution: 320 x 240 pixels
- Power supply: 100V-240V AC, 50Hz-60Hz; DC INPUT 5V DC-2A
- Battery: 2 x 2600 mAh
- Dimensions: 199 x 98 x 40 mm
- Weight: 624g

**Multimeter Specifications:**

- Test: Voltage, Current, Resistance, Capacity, Diodes and On-Off
- Max. voltage: 600V AC-DC
- Max. current: 10A AC-DC
- Max. resistance: 40MOHM
- Max. capacity: 100uF

**Oscilloscope Specifications: Horizontal**

- Bandwidth: 40MHz
- Sampling frequency range: 250MSa/s (single channel) - 125MSa/s (double channel)
- SEC/DIV range: 5ns/div ÷ 500s/div 1,2,5 sequence

**Vertical**

- VOLTS/DIV range: 10mV/div÷10V/divat BNC input
- Selectable analogue, bandwidth limit, typical: 20MHz
- Low frequency response (-3db): ≤10Hz a BNC
- DC Gain Accuracy: ± 3% for Normal or Medium acquisition mode, 10V/div ÷ 10 mV/div

**Trigger**

- Type: Edge
- Mode: Auto, Normal, Single
- Slope: Rising, Falling, Rising, & Falling
- Source: CH1, CH2

**Input**

- Coupling: DC, AC or GND
- Supported probe attenuation factors: 1X, 10X, 100X, 1000X

**Arbitrary waveform generator**

- Waveform frequency: Sine (1Hz÷25MHz), Square (1Hz÷10MHz), Ramp (1Hz÷1MHz), EXP (1Hz÷5MHz)
- Width: 2.5Vpp (50Ω) - 5Vpp (high impedance)
- Output impedance: 50Ω



**1760DGT**

017600005

314,00 €  
**154,00 €**

**Digital automotive multimeter**

**Technical Data:**

- **RPM (tachometer):**  
For 2 and 4 cylinder engines  
RPM4 600 - 4000 RPM  
RPM4 600 - 12000 RPM (x10 RPM)  
RPM2/DIS 300 - 4000 RPM  
RPM2/DIS 300 - 6000 RPM (x10 RPM)
- **Dwell angle:** 4-8 CYL
- **DC voltage:** 400mV-4/40/400/1000V
- **AC voltage:** 4/40/400/700V
- **DC current:** 40/400mA-4/20A
- **AC current:** 40/400mA-4/20A
- **Resistance:** 400Ω-4/40/400kΩ-4/40MΩ
- **Capacity:** 40/400nF-4/40/100μF
- **Frequency:** 5/50/500Hz-50/500-10MHz
- **Duty cycle:** 0.1 % - 99.9%
- **Pulse amplitude:** 1 - 10ms
- **Diode test:** Test current 0.3mA
- **Continuity:** <150Ω - Test current <0.3mA
- **Display:** High-contrast, backlit 4-digit LCD
- **Overvoltage:** Category II 1000V
- **Auto power off:** 30 minutes
- **Power supply:** 1 9V battery (included)
- Inductive clamp (included)
- 2 tips (included)
- Soft cloth case (included)
- Operating manual



**1760B**

017600012

202,50 €  
**109,00 €**

**Digital multimeter**

**SPECIFICATIONS**

- DC voltage: 200 mV-2/20/200/1000
- VAC voltage: 2-20/200/700VDC
- current: 2/20/200 mA-20 AAC
- current: 2/200 mA- 20 A
- Resistance: 200Ω - 2/20/200 kΩ - 2/20 MΩ
- Capacity: 2/20/200 nF - 2/200 μF
- Temperature: -20° + 1000°C/ -4 °F ~ +2000°F
- Frequency: 20kHz
- Power supply: 1 9V battery (included)

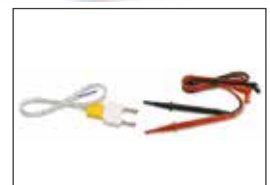



**1760PA/80**

017600002

261,00 €  
**151,00 €**

**AC/DC amperometric clamp, 80A**  
Specifically designed to measure low current leakage or absorption values on vehicles



**IDEAL FOR LOW LEAKAGE VALUES 1mA-80A**

- Range: 1mA-80A AC/DC
- Torch function with white LED
- Backlit LCD display
- Zero setting function
- Hold function
- Auto power off
- Power supply: 2 1.5V AAA-type batteries



**1760PA/AC-DC**

017600000

387,00 €  
**219,00 €**

**Amperometric clamp and digital multimeter**



**1000A**

**SPECIFICATIONS**

- DC voltage: 0.1mV ÷ 600V
- AC voltage: 0.1mV ÷ 600V
- AC current: 0.01A ÷ 1000A
- DC current: 0.01A ÷ 1000A
- Resistance: 0.1Ω ÷ 40MΩ
- Capacity: 0.001nF ÷ 40 μF
- Frequency: 0.001kHz ÷ 4kHz
- Temperature: -40°C ÷ 1000 °C  
-40°F ÷ 1832°F



**1760PA/AC-DC2000**

017600003

763,00 €  
**439,00 €**

**Amperometric clamp with digital multimeter and data connection**



**2000A**

**Measurable parameters:**

- DC voltage: 0.1mV ÷ 1000V
- AC voltage: 0.1mV ÷ 1000V
- AC current: 0.01A ÷ 2000A
- DC current: 0.01A ÷ 2000A
- Resistance: 0.1Ω ÷ 60MΩ
- Capacity: 1nF ÷ 6000 μF
- Frequency: 10kHz ÷ 20kHz
- Temperature: -20 °C ÷ 1000 °C  
-4 °F ÷ 1832 °F
- Power supply: 3 1.5V batteries, type AA (included)
- Data connection (version 4.0)



240x210x50 mm

**1760/TC2**

017600161

271,00 €  
**143,00 €**

**Combination contact/non-contact digital tachometer**



**TECHNICAL DATA**

- For measuring:
  - non-contact rotational speed (rpm)
  - contact rotational (rpm) and linear surface speed (m/min or ft/min).
- 5-digit LCD display.
- Scale:
  - non-contact speed 2.5÷99,999 rpm
  - contact speed 0.5÷19,999 rpm
  - linear surface speed 0.05÷1,999.9 m/min.
- Frequency: 0.8 sec.
- Power supply: 4 1.5V batteries (included), AA size, or 6V power supply unit (not included).

**Supplied with the following:**

- Adaptor for contact tip measurement
- Male (contact) rubber tip (2 pcs.)
- Female (contact) rubber tip (1 pcs.)
- Linear measurement tape (1 pcs.)
- Reflecting tapes
- Instruction manual
- Plastic case



## 1760/IR500

017600350

186,50 €  
105,00 €

### Digital infrared thermometer with dual laser aiming system

#### TECHNICAL DATA

Temperature range:  $-50 \div 500 \text{ }^{\circ}\text{C}$  ( $-22 \div +932 \text{ }^{\circ}\text{F}$ )  
 Display resolution:  $0.1 \text{ }^{\circ}\text{C}$  ( $0.1 \text{ }^{\circ}\text{F}$ )  
 Emissivity:  $0.1 \div 1$  adjustable  
 Accuracy:  $-50 \text{ }^{\circ}\text{C} \div +20 \text{ }^{\circ}\text{C}$  ( $\pm 3 \text{ }^{\circ}\text{C}$ );  
 $20 \div 500 \text{ }^{\circ}\text{C}$  ( $\pm 2\%$  or  $2 \text{ }^{\circ}\text{C}$ )  
 Optical resolution (D:S): 12:1  
 Auto power off: ca. 10 seconds  
 Operating temperature:  $0 \text{ }^{\circ}\text{C} \div 50 \text{ }^{\circ}\text{C}$   
 Storage temperature:  $-20 \text{ }^{\circ}\text{C} \div 60 \text{ }^{\circ}\text{C}$   
 Power supply: 1 9V battery



## NEW

## 961N

009610030

528,00 €  
307,00 €

### Electronic videoscope with flexible, rotating probe

- TFT LCD 5" screen
- Supports SD cards
- Video and image recording
- 4 LEDs
- Power supply via USB port (built-in battery)
- Rotating probe
- High resolution

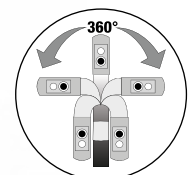
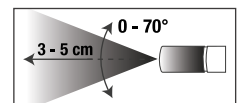
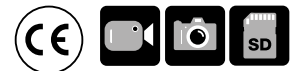

Discover the videoscope, 961N, your versatile partner for all jobs! Based on the probe that can be rotated 360° and the double lit camera reaching the most inaccessible points has never been so easy. Defects and problems can be found easily and accurately. And with the new TFT LCD 5" display and outstanding resolution (1920x1080), you can enjoy sharp, bright images and videos, like never before. Choose the videoscope, 961N, for uncompromised quality.



## CB52-0

052000201

870,00 €  
483,00 €

### Gearbox/transmission trolley with liquid recovery system

Inclined plane and drain holes allow liquids to be recovered in collection tank

Fitted with:

- 4 swivel castors, including 2 with brakes
- Tool drawer
- Pull-out liquid collection tank; capacity: 7 l
- 2 shelves



**CAPACITY 7 L**

### Exhausted oil drain unit

- Level indicator
- Big diameter pan with breakwater grate; capacity: 12 l
- Pneumatic tank emptying through 1.8 m pipe
- Tool tray



## 1877

018770008

824,00 €  
475,00 €

Exhausted oil drain unit, wheeled, with 90 l tank

## 1877A

018770080

1.468,00 €  
825,00 €

Exhausted oil drain unit / vacuum cleaner, wheeled, with 90 l tank and pre-chamber

- Transparent pre-chamber; capacity 9.5 l
- Pneumatic tank emptying through 1.8 m pipe

Standard accessories:

- 1 hard probe, Ø 5x700 mm
- 1 flexible probe, Ø 5x700 mm
- 1 hard probe, Ø 6x600 mm
- 1 flexible probe, Ø 6x700 mm
- 1 flexible probe, Ø 7x700 mm
- 1 flexible probe, Ø 8x700 mm
- Adapters for VW, BMW, CITROËN



## 1877P

018770180

638,00 €  
279,00 €

Exhausted oil drain unit, wheeled, with polyethylene tank

- Tank capacity: 40 l
- Large oil pan made of PP
- Level indicator
- Pneumatic drum emptying



## 1877F

018770100

112,00 €  
65,00 €

Exhausted oil drain unit for 1 l bottles

- Fits up to 4 bottles at a time
- Supplied with 2 2-l jerrycans

**FITS UP TO 4 BOTTLES AT A TIME**





**1758B-RNT**

017580035

~~30,50 €~~  
**19,00 €**

**Non-return quick coupling for funnel item 1758B**

For Renault 1.5 dCi engine



**1758B**

017580030

~~42,50 €~~  
**25,00 €**

**Non-return funnel with quick couplings**

Particularly suitable for VAG cars.



**NON-RETURN**



**1758ADB-45°**

017580060

~~43,50 €~~  
**25,00 €**

**Non-return funnel for AdBlue®, with 45° coupling**

Capacity: 1 l



**1756G**

017560615

~~141,00 €~~  
**80,00 €**

**Diesel oil gun capacity: 1.5 l**

- Can be used to:
- Fill diesel oil filters
  - Fill Cerina tank

- Kit contents:
- 2 pipes with female quick couplings for connecting diesel oil pipes
  - 2 male quick couplings, made of metal
  - 1 cone-shaped adapter for rubber pipes



**1756B**

017560220

~~26,00 €~~  
**14,00 €**

**Pen oiler**

- With non-slip knurl
- Operating temperature: -10 °C - +60 °C
- Minimum density of SAE 10 oil



**1756E**

017560610

~~47,50 €~~  
**26,00 €**

**Siphon syringe, compatible with petrol**

Syringe capacity: 200 ml

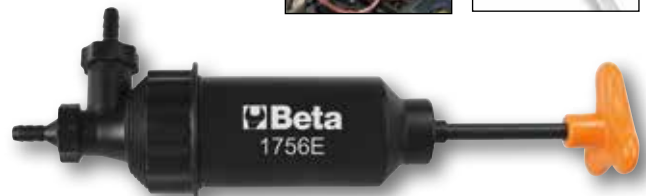

**1756V**

017560504

**NEW**

~~45,50 €~~  
**26,00 €**

**Oil suction gun, 200 ml, made from polypropylene**

- For transferring oil and brake fluid
- Operating temperature: +0 °C ÷ +50 °C
- Not suitable for fuel and flammable liquids
- Usable minimum oil density: lower than SAE30



**1482SN**

014820110

~~78,00 €~~  
**41,00 €**

**Quick coupler swivel pliers for fuel pipes, with articulated jaws**



L mm
260

**1488**

**Oil-filter wrench with double chain**

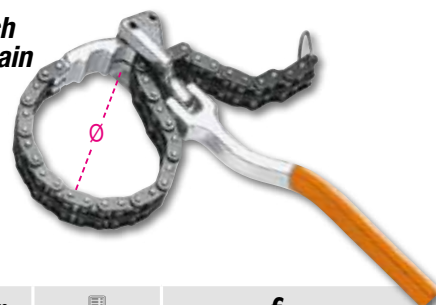

	Ø mm		€	€
<b>1488</b>	60÷110	014880001	<del>108,00 €</del>	<b>54,00 €</b>
<b>1488L</b>	60÷160	014880050	<del>118,50 €</del>	<b>61,00 €</b>

**1491**

014910001

~~55,50 €~~  
**28,00 €**

**Adjustable oil filter wrench**

Ø mm
65÷110



**1490**

**Strap wrenches for oil filters**

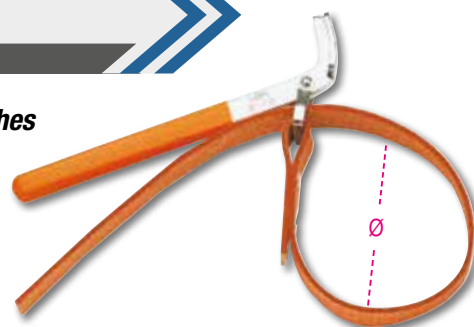

	Ø max mm		€	€
<b>1490/1</b>	160	014900001	<del>43,00 €</del>	<b>21,00 €</b>
<b>1490/2</b>	240	014900002	<del>46,00 €</del>	<b>23,00 €</b>

**1493FF/2**

014930128

~~124,50 €~~  
**72,00 €**

**Oil filter wrench with swivel ratchet head**

This wrench has been specially designed to make it easier to remove and install oil filters of PSA Group and Ford vehicles.



**1/2"**

**1493/C30**

014930000

~~315,00 €~~  
**152,00 €**

**Set of 28 oil filter wrenches**

- For tightening and loosening oil filters
- 1/2" female drive
- In plastic case

530x400x110 mm

Sizes included in kit (Ø mm / n° lati) 1493:  
65/14 - 67/14 - 68/14 -  
73/14 - 74/15 - 76/15 -  
75.77/15 - 76/14 - 76/8 -  
78/15 - 80/15 - 82/15 -  
86/16 - 90/15 - 92/10 -  
93/15 - 95/15 - 100/15 -  
106/15 - 108/15



1493PF (Purflux)  
66/6 - 76/12 - 76/30 - 86/18  
93/36 - 93/45 - 96/18 - 108/18

Includes 1 adjustable oil filter wrench Ø 65÷120 mm

## 1899SI

018990030

5.460,00 €  
2.849,00 €

11,6 kg

### 2-in-1 machine for cleaning injectors and intake manifold

#### Specifications:

- Operating voltage: 12 V
- 2 service hoses with quick couplers
- 2 tanks (capacity: 1 l each)

270 mm  
420 mm  
385 mm



Special detergents can be used to periodically clean the injectors and the intake manifold in diesel and petrol engines, removing carbonaceous deposits and combustion residues.



## 1899A/M

018990011

1.560,00 €  
879,00 €

### DPF/FAP® system cleaning machine

#### Supplied with:

- 1 2-m-long feed pipe
- 1 quick coupler + hose nozzle for differential sensor hoses
- 1 niple M18x1.5 with hose nozzle for direct connection to lambda probe
- 1 extension hose
- 1 DPF/FAP® spray nozzle
- 1 magnetic pipe support
- 1 DPF/FAP® pipe with adjustment cable gland plus niple M14/16/18 mm for connecting lambda probes



#### Technical specifications:

- Operating voltage: 12 V
- Power supply cord length: 3.9 m
- Tank capacity: 1 l



Special detergents can be used to periodically clean and restore DPF and FAP® systems damaged by soot and ash deposits. Results can be checked by self-diagnosis, which allows soot mass and differential pressure in diesel particulate filter before and after treatment to be determined.

## 1852R1750

018520175

1.775,00 €  
989,00 €

### Portable induction heater

- Heats and loosens bolts, hubs and bearings without using flames.
- Allows any type of ferromagnetic metal to be heated.

#### Technical data:

- Input voltage: 230V AC, 50/60 Hz
- Input current: max. 7,5A
- Power: max. 1.75 kW

#### Benefits

- 1 Time saving: quick, extremely accurate heating
- 2 Fire safety: does not produce flames, maximum operator safety
- 3 Functional: can be used with one hand, and coils can be easily interchanged

#### Fields of Application:

- Automotive industry
- Industrial maintenance
- Aviation industry
- Naval industry
- Petrochemical industry



480x370x130 mm

#### Standard equipment:

Two front attachable coils, Ø 19 and 26 mm, for loosening nuts



One flat coil for heating surfaces



One flexible coil, 800 mm long



## 1852S-CNT

018520520

130,50 €  
74,00 €

### Contact coil



**MAXIMUM SAFETY  
WITHOUT USING FLAMES.**



**960VTC**

009600261

325,00 €  
**186,00 €**

**Leakage tester for petrol engine cylinders**

After compressed air has been introduced into cylinder, gauge will allow it to be tested for compression leaks.

2,3 kg

Supplied couplers:  
M10 - M12 - M14 - M14 long

373x295x70,6 mm



**1472PU/P**

014720121

119,00 €  
**68,00 €**

**Combination collar and hose clamp pliers with extension**

The unique shape of the multi-head jaws of these pliers make it possible to use the tool on a wide range of commercially available collars

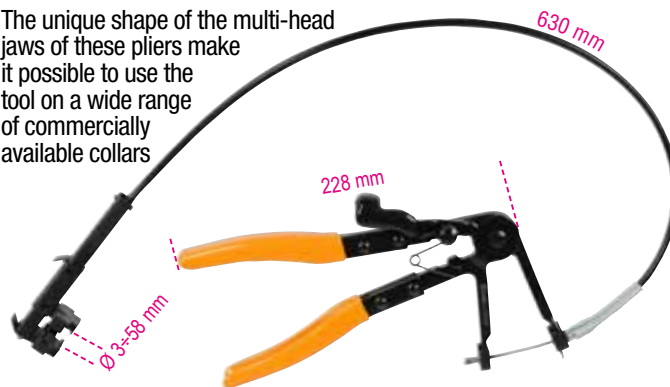

**1472PU**

014720120

80,50 €  
**46,00 €**

**Combination collar and hose clamp pliers**

The multi head jaws inclined at 45° allow most commercially available collars to be clamped.



**960KC-M8/M9/M10**

009600801

510,00 €  
**294,00 €**

**Assortment of tools for removing broken or damaged glow plugs**

**FOR SPARK PLUGS WITH THREADS M8-M9-M10**

380x290x50 mm



**960PI/K36**

009600218

222,00 €  
**130,00 €**

**Kit of brushes for cleaning injector seats**

Kit contents:

- 12 nylon brushes, 8÷19 mm (1 mm interval)
- 12 steel brushes, 8÷19 mm (1 mm interval)
- 12 brass brushes, 8÷19 mm (1 mm interval)
- 1 bit holder with quick coupling and magnetic bottom
- 1 extension with quick coupling and magnetic bottom

350x255x74 mm



1,2 kg

**960KPC**

009600780

368,00 €  
**217,00 €**

**Reversible impulse extractor with adjustable torque for glow plugs**

- Pneumatic extractor with adjustable torque and special sockets allow jammed glow plugs to be unscrewed, thereby minimizing damage risk
- 5 1/4" impact sockets, long series, specially designed for glow plugs: 8-9-10-11-12 mm, 2 extensions and 1 articulated joint
- 4 adjustable driving torques: 10-20-30-40 Nm
- Right-hand and left-hand adjustment



**1884**

018840010

564,00 €  
**329,00 €**

**Oil filler tool for manual and automatic gearboxes and differentials**

- Complete with 12 adaptors for direct connection
- Fitted with nonreturn valve for leakage-free oil filling
  - Delivery: 70 cc per pump shot
  - Tank capacity: 7.5 l
  - Maximum permissible oil viscosity: SAE 140



12 ADAPTORS	FORD	AT-101
	UNIVERSAL (Bmw, Honda, Nissan...)	AT-102
	VW-AUDI	AT-103
	VW-AUDI-PORSCHE	AT-104
	VW-AUDI-MINI COOPER	AT-105
	MERCEDES	AT-106
	DSG	AT-107
	VW-AUDI CVT	AT-108
	VOLVO	AT-109
	TOYOTA-LEXUS	AT-110
	SKODA	AT-111
	VW Passat/Tiguan <2007	AT-112

**1884N/C8**

018840200

137,00 €  
**78,00 €**

**Set of 8 adapters for item 1884**

- Set contents:
- 1 adapter for Infiniti, 7-speed, M8x1.0
  - 1 adapter for Honda, Hyundai, Kia 5x8x200 mm
  - 1 adapter for Skoda M18x1.5
  - 1 adapter for Mini M14x1.5
  - 1 adapter for Nissan M10x1.5
  - 1 adapter for Nissan Juke M12x1.25
  - 1 adapter for GM M12x1.75
  - 1 adapter for VAG group vehicles, 7-gear



200x145x40 mm



**1759LR**

017590070

514,00 €  
**285,00 €**

**Cooling system washing tool**

**REMARKABLE WATER POWER**

Based on the use of compressed air, high water pressure allows for effective cleaning system washing.

- Supplied with 6 system connection adapters
- Operating lever with position locking for continuous use
- Supplied with a water quick coupling



390x330x100 mm



**1758RD**

017580070

131,00 €  
**74,00 €**

**Coolant funnel with quick couplings**



**1759HD/3**

017590063

669,00 €  
**329,00 €**

**Cooling system seal testing and circuit filling tools**

Make it possible to check circuit (pipes, joints, pumps, radiators) for leaks under pressure and quickly fill circuit, avoiding air bubble formation.

600x500x140 mm



**NEW**
**1477/C38**

014770338

~~264,00 €~~
**153,00 €**
**Kit with swivel ratcheting wrench,  
with short sockets for belt tighteners**

Kit contents:

- Swivel lever with 500-mm long reversible ratchet
- Short sockets for Torx® head screws: E10-E12-E14-E16-E18
- Short hexagon sockets: 8-9-10-11-12-13-14-15-16-17-18-19-24
- Bits for Torx® head screws: T20-T25-T27-T30-T40-T45-T50-T55-T60
- Bits for cross head Phillips® screws: PH2
- Hexagon bits: 4-5-6-7-8-10 mm
- Magnetic bit holder
- 3/8" extension, 75 mm

**1462/KI**

014620235

~~2.930,00 €~~
**1.429,00 €**
**Assortment of common rail diesel  
injector pullers**

Allows DELPHI-BOSCH-SIEMENS-DENSO injectors to be removed

- Mechanical and hydraulic operation
- Includes one 12-t hydraulic jack
- Can be directly used on vehicle with mounted engine
- Numerous adjustment options on head make it possible to work on most engines available



530x470x140 mm

**1462/EI**

014620240

~~173,00 €~~
**439,00 €**
**Universal vibration tool  
for injector removal**

- Helps to fully remove jammed injectors from their housings, without damaging cylinder heads and without breaking injectors
- Can be used with any injector removal set, with or without hammer face
- Tool acts directly on removal tie rod, which is coupled with injector, through vibrations and pulses
- Control valve allows vibration intensity to be adjusted to type of work to be carried out

**1462/MB**

014620110

~~352,00 €~~
**193,00 €**
**Hammer face kit  
for removing injectors**

Kit contents:

- 1 4 kg hammer face with 400 mm rod
- 1 articulated adapter, male M10x1.5, female M22x1.5 mm
- 1 adapter, male M22x1.5, female M13x1.4 mm
- 1 adapter, male M14x1.5, female M27x1 mm
- 1 adapter, male M14x1.5, male M25x1 mm
- 1 adapter, male M14x1.5, male M27x1 mm
- 1 adapter, male M14x1.5, female M14x1.5 mm
- 1 adapter, male M14x1.5, male M20x1 mm
- 1 adapter, male M14x1.5, male M17x1 mm

500x250x80 mm





## 1898/K40

018980004

5,350,00 €  
2.639,00 €

### Eco friendly, heated manual cleaning tank

- Using the bio-active liquid included, oil and residue can be effectively removed from mechanical parts without the need for aggressive chemicals
- The bio-active liquid converts the oil and other residue into carbon dioxide and water which can be re-used again and again
- no need for specialist waste collection and disposal
- suitable for both metal and plastic parts

#### Equipment:

- Long bristle brush and connecting pipe
- Right-hand and left-hand operation function
- Perforated stainless steel grid
- Wheels with brakes
- Card with display operating temperature and low level alert



**ATTENTION:**  
Countries where product 1898/K40 is allowed to be distributed: Austria, Belgium, France, Hungary, Italy, Netherlands, Poland, Portugal, Spain, United Kingdom.

**Accessories Included:**  
2 20 l cans of environmentally friendly liquid detergent and 2 packs of bacteria



Max. pump capacity	10 l/min
Tank capacity	40 l
Operating temperature	+5°C ÷ +40°C
Weight	50 kg (when empty)
Dimensions	710x370x200 mm

## 1895

### Ultrasonic cleaning tank with special degas function

- Ultrasonic cleaning relies on fluid heating to effectively clean spare parts and metal pieces in general (carburetors, valves etc.)
- Digital display for temperature and cleaning time selection
- Two cleaning modes: "soft" and "normal"
- For normal cleaning, just use water at a temperature of 50/60 °C
- For more accurate cleaning, add non-foaming detergent solutions specific for ultrasonic tanks
- Using the degas mode speeds up air release throughout the tank, thereby improving ultrasonic cleaning efficiency



### 1895 6

018950060

836,00 €  
483,00 €

6 l

### 1895 13

018950130

1.295,00 €  
747,00 €

13 l

### 1895 27

018950270

1.805,00 €  
1.044,00 €

27 l

### 1895 157

018950357

**NEW**

8.310,00 €  
4.399,00 €

157 l



	1895 6	1895 13	1895 27	1895 157
Tank capacity	6 litres	13 litres	27 litres	157 litres
Drain tap	✓	✓	✓	✓
Power	150 Watt	300 Watt	500 Watt	2160 Watt
Heating power	300 Watt	400 Watt	500 Watt	5000 Watt
Temperature range	0÷80 °C	0÷80 °C	0÷80 °C	30÷110 °C
Cleaning time range	0-99 minutes	0-99 minutes	0-99 minutes	0-59 minutes
Frequency	40 kHz	40 kHz	40 kHz	28 kHz - 40 kHz
Power supply	220/230V	220/230V	220/230V	220/380V
Dimensions	330x180x310 mm	350x325x320 mm	530x330x380 mm	840x640x750 mm
Tank size	300x155x150 mm	325x235x145 mm	500x300x200 mm	700x500x450 mm

### 9881U

098810010

39,50 €  
22,00 €

### ULTRASONIC CLEANER

Industrial alkaline detergent for ultrasonic tank



**Multi-purpose trolley**

Can be used as a mobile workstation for diagnostic tools, laptops, testers and battery chargers

- Painted sheet metal frame: unparalleled firmness and sturdiness
- Ergonomic handle
- 2 fixed rear castors Ø 160 mm
- 2 steering front castors Ø 125 mm (one with brake)



2-level top

2 central shelves with adjustable position and 1 fixed low shelf

1099 mm  
460 mm  
435 mm



Pull-out drawer for housing a mini keyboard



1 paper holder



4 useful side cable reels made of plastic



2 useful side containers

**CA49-G**

049000112

1.013,00 €  
**549,00 €**

36,5 kg

Multi-purpose trolley with door, empty

**CX49-G**

049000102

902,00 €  
**494,00 €**

43 kg

Multi-purpose trolley, empty

**1466/C5**

014660100

150,50 €  
**87,00 €**

**Kit of 5 brake bleeding wrenches**

kit contents:

- 5 wrenches sizes 7-8-9-10-11 mm
- 1 drain hose with check valve

**OIL GOES INTO BUSH.**



260x170x50 mm



**1471M/C22**

014710101

359,00 €  
**193,00 €**

**Pneumatic tool for pushing back and rotating right and left disc brake pistons with accessories**

- Automatic jack
- New assortment complete with all new adaptors
- Thrust: 150 kg
- Operating pressure 5÷8 bar

350x310x85 mm



**1471C**

014710330

72,50 €  
**42,00 €**

**Tool for manually pushing back brake pistons, with ratchet**

The tool for manually pushing back brake pistons, fitted with two swivel plates and a ratchet movement mechanism, means an effective, flexible solution for quick jobs - e.g. on commercial vehicles.



### 1471PT/C5

014710367

86,00 €  
50,00 €

#### Impact socket kit for brake calipers nuts

For cars of Volkswagen, Audi & Porsche group

- 3 10-tooth sockets: 11.5 mm - 15 mm - 20 mm
- 2 7-tooth socket: Ø 14 mm - 22 mm

Ø mm	L mm
25	50



7 teeth 10 teeth



12"

### 1467LF/2

014670099

2.095,00 €  
1.099,00 €

#### Electric instrument for brake fluid replacement



Allows brake fluid to be easily and quickly replaced on vehicle

- Automatically stops when tank is empty, thereby preventing air from being let in
- Maximum tank volume: 20 l
- Operating pressure: 0.4÷3.5 bar
- Power supply: 230V

Supplied with:

- Brake oil recovery tank
- 1 standard cap E20

“PULSATING EFFECT”

15 kg



### 1467

014670001

402,00 €  
186,00 €

#### Brake fluid extractor

Pressure: min 5 bar,  
max 11.5 bar



### 1467T/C6

014670080

319,00 €  
186,00 €

#### Set of adapter plugs for brake fluid tanks, for use with BETA items 1467LF and 1467LF/2



Set contents:

- 1 plug for Toyota vehicles
- 1 plug for Ford, Hyundai, Mazda, Mitsubishi, Nissan, Subaru vehicles
- 1 plug for Honda vehicles
- 1 plug for Mazda and Suzuki vehicles
- 1 plug for Nissan vehicles
- 1 brake bleeding adapter plug for European vehicles

350x240x85 mm





**1950BZK**

019500078

366,00 €  
**218,00 €**

**Tyre bead seater**

Ø 290x440 mm

- Secondary handle with push-button operation helps keep hold of tool during use
- Tank capacity: 18 l
- Operating pressure: 3-8 bar
- Maximum tank pressure: 16 bar
- Pressure relief valve
- Gauge with graduated scale
- Plastic inlet preventing rim damage



**NEW**

**1950BZK/T**

019500080

457,00 €  
**259,00 €**

**Truck tyre bead seater**

- Tank capacity: 36 l
- Operating pressure: 3-8 bar
- Maximum tank pressure: 16 bar
- Pressure relief valve
- Gauge with graduated scale
- Plastic inlet preventing rim damage

Ø 290x560 mm

**Tyre inflator**

- Shockproof rubber coated body
- Metal operating lever
- Operating pressure: 0,5÷12 bar, 7÷174 psi
- Pipe length: 58 cm
- 360° hose rotation
- 1/4" air inlet

**1949GPA**

019490018

126,50 €  
**54,00 €**

- Pressure release feature
- Pressure measurement feature



**1949DGT/2**

019490021

151,50 €  
**65,00 €**

**DIGITAL**

**Digital tyre inflator**

- 4 units of measurement, bar/psi/kpa/kgf
- Backlit LCD display
- Resolution: 0.05 bar
- Self-power off after 1.5 minutes



**962**

**Tyre levers**



	L mm	A mm		€
<b>962 500</b>	500	27	009620005	<del>43,50 €</del> <b>25,00 €</b>
<b>962 600</b>	600	27	009620006	<del>56,50 €</del> <b>32,00 €</b>

**3035**

030350100

1.133,00 €  
599,00 €

**Tyre trolley**

- For easily transporting tyres up to 980 mm in diameter
- The sturdy frame allows tyres to be handled without bearing the weight physically
- Can be used as a top by locking position horizontally
- 2 castors Ø 260 mm
- 2 castors Ø 125 mm
- Maximum transportable height: 1.60 m
- Maximum carrying capacity: 200 kg
- Forks can be adjusted in 2 positions:  
first position: maximum opening 880 mm  
second position: maximum opening 980 mm



30 kg



**978 - 979**

12"

**Four-way hexagon wheel nut wrenches**

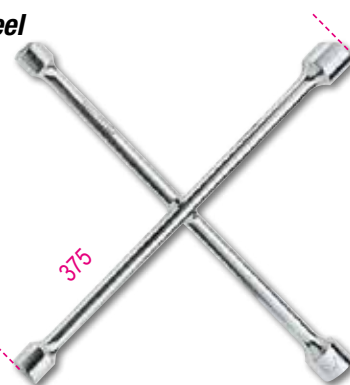

			€
978	17x19x21x22 mm	009780001	<del>76,00 €</del> <b>39,00 €</b>
979	17x19x22x1/2 mm	009790001	<del>76,00 €</del> <b>39,00 €</b>

**989**

009890001

~~56,50 €~~  
**32,00 €**

**Wheel balancing weight tool**



L 250 mm

**972/C10**

009720010

~~342,00 €~~  
**197,00 €**

**Removal kit for damaged wheel nuts**

For use on anti-theft and conventional nuts



290x250x60 mm



**972/C4BMW**

009720004

~~271,00 €~~  
**157,00 €**

**Removal kit for anti-theft bolts with free rings, for BMW and Mini cars**



516x145x66 mm



**720LC/C3**

007200653

44,00 €  
**26,00 €**

**3 impact sockets for wheel nuts, with polymeric inserts**

- 17-19-21 mm
- ≡ 148x132x44 mm



**986 78**

009860078

17,40 €  
**10,00 €**

**Tyre valve screwdriver**

Automatic valve retention.

L mm	L1 mm
78	18



**983PM**

009830010

88,50 €  
**52,00 €**

**Abrasive brush for cleaning hubs**



Ø1 mm	Ø2 mm
90	150

**720RNG**

007200634

22,30 €  
**14,00 €**

**Impact socket for Jeep Renegade wheel nuts with aluminium damaged caps**

Required when nut caps are damaged by impact wrenches.



mm	L mm
16,5+17,5	63

**720MRC**

007200631

23,50 €  
**14,00 €**

**Impact socket with polymeric insert for Mercedes wheel screw**

Suitable for the following Mercedes models:

- Classe C e GLK (W204)
- Classe E (W211, W212, W207)
- Classe SLK (W172)
- Classe ML (W164, W166)
- Classe CL (W216)
- Classe S (W221, W222)



mm	L mm
17	85

**720FRD**

007200633

22,30 €  
**14,00 €**

**Impact socket for Ford wheel nuts with aluminium damaged caps**

Required when nut caps are damaged by impact wrenches



mm	L mm
18,5+19,5	63

**984**

009840005

30,50 €  
**17,00 €**

**Wheel nut plastic cap pliers**

Length: 195 mm





**3008M**

030080210

143,00 €  
**83,00 €**

**Manual jack and positioner for truck wheels**

This jack, which has a maximum carrying capacity of 136 kg, has been designed to make it easier to lift and handle large tyres. The frame with increased thickness and the reinforcements applied to the welding areas provide this device with remarkable sturdiness and firmness.

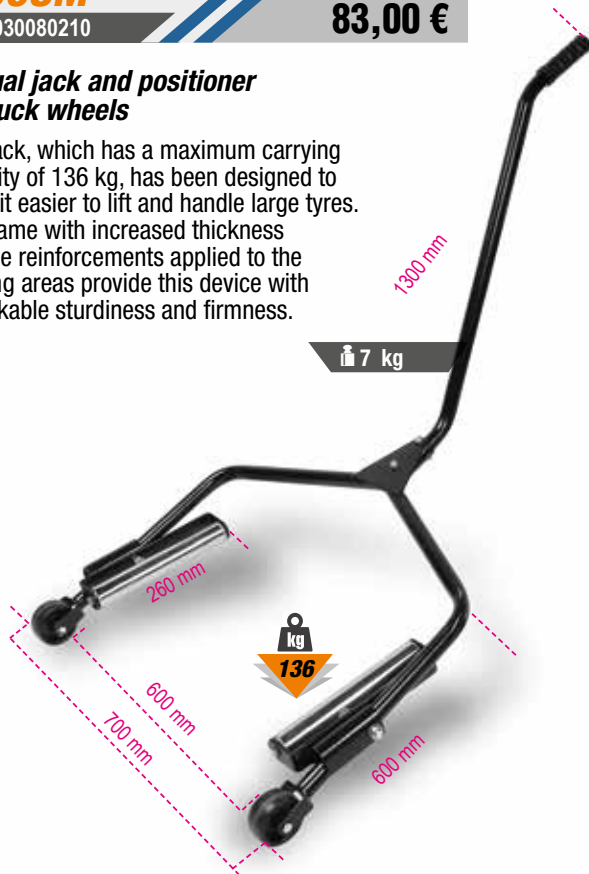

**1567**

015670001

392,00 €  
**186,00 €**

**Lever for removing wishbone heads and shock absorbers from pillar**

One operator can position lever effortlessly and proceed with disassembly

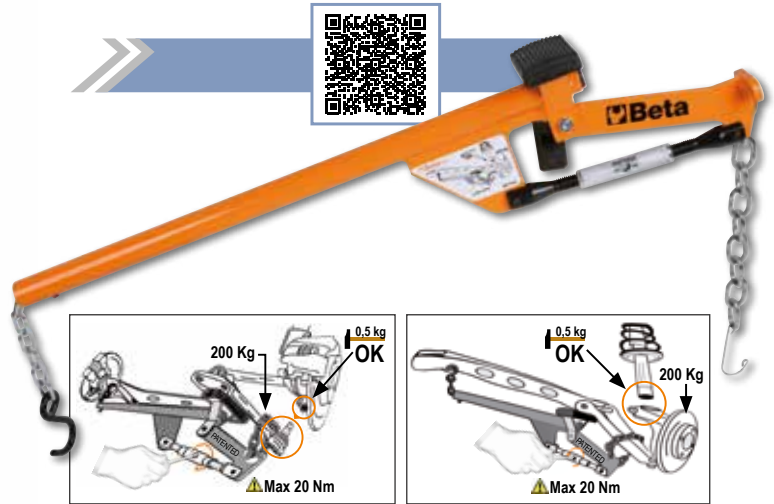

**1471**

014710001

91,50 €  
**43,00 €**

**Drum brake spring pliers**



**1568**

015680001

279,00 €  
**162,00 €**

**Pneumatic assembly tool for silicone axle shaft boots**

- 8 spreader arms maximum arms
- preading: 145 mm



L mm	L1 mm
420	195



**1566/VAG**

015660060

48,50 €  
**23,00 €**

**Kit of XZN® impact sockets for axle shaft screws of VAG Group vehicles**

Sizes included in kit:

- XZN® male impact socket M12 L 77 mm
- XZN® male impact socket M12 L 120 mm

This kit of impact sockets with XZN® M12 profile, available in two different lengths, has been specially designed to make it easier to remove the three screws from the axle shaft - gearbox side - in VAG Group vehicles. This allows the axle shaft to be pulled out, without requiring the accessory parts to be removed.



12"

M12

## 1552/C9

015520020

146,00 €  
83,00 €

### Kit for spreading shock absorber, wishbone and steering wheel joints apart

Working with single or double retractor head also makes it possible to work on double joints, e.g. from VAG group.



195x140x40 mm

## 1556/1A

015560101

274,00 €  
142,00 €

### Compressor for shock absorber springs

min L Max 65÷320 mm



## 1550U

015500010

3.480,00 €  
1.869,00 €

### Pneumatic shock absorber removal tool for cars, SUVs and commercial vehicles

- Upper universal hold system that allows all left/right-hand spring diameters to be compressed with one upper adaptable plate
- Active safety system on spring: safety hook and 3 locking valves allow spring to be properly positioned/seated, maintaining such position throughout compression. If spring is not positioned properly, system will stop machine.
- Protective "Full Body" Grille



1670 mm  
610 mm  
825 mm

**MAXIMUM THRUST  
2 TONS (10 BAR)**



- Supplied with 2 lower forks for diameters 78-205 mm
- Maximum thrust:  
2 tons (10 bars) - 1.6 tons (8 bars) - 1.2 tons (6 bars)
- Spring compression stroke: 335 mm



## 1569/SB

015690016

289,00 €  
156,00 €

### Assortment of tools for removing and installing rear axle silent blocks, driving shaft oil seals and wheel bearings

- Bushings can be used both on vehicle and on hydraulic press

425x365x100 mm



## 1068

010680000

140,50 €  
80,00 €

### Adjustable self-locking pliers with hammer face

The self-locking pliers with 1 kg sliding hammer face is ideal for pulling stud bolts, broken screws and sheets, especially in the car repair industry.

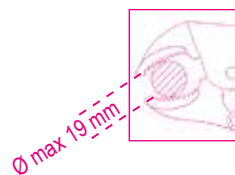

260 mm

365 mm

1 kg

## 1364SE

013640001

470,00 €  
268,00 €

### Extension bodywork support

- 4 swivel castors, 2 with brakes
- Pantograph can be extended up to 1400 mm
- Vertically adjustable up to 1315 mm
- Position locking
- Contact surface covered with removable rubber

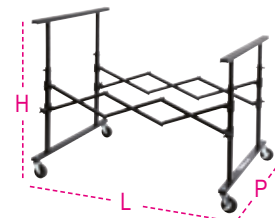

L mm	H mm	P mm
215÷1400	780÷1315	890

## 1364SV

013640002

267,00 €  
153,00 €

### Bodywork support with central tray

- Contact surface covered in polyethylene
- Tray dimensions: 340x845x40 mm
- Foldable



H mm
1000

## 1364SCP

013640003

428,00 €  
244,00 €

### Revolving bodywork support

- Particularly suitable for bonnets, wings and doors
- Fitted with 4 castors - 2 steering with brakes
- Can be rotated up to 180°



**CAN BE ROTATED UP TO 180°**

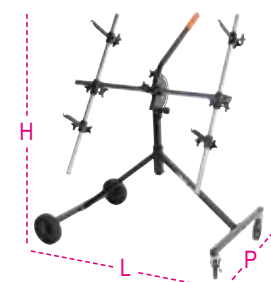

L mm	H mm	P mm
1100	1300	680



**1052**

**Adjustable self-locking pliers, concave jaws**

	L mm	ø Max mm	g	Art. No.	€
<b>1052/140</b>	140	22	175	010520014	<del>31,00 €</del> <b>18,00 €</b>
<b>1052/190</b>	190	36	360	010520019	<del>34,50 €</del> <b>20,00 €</b>
<b>1052/240</b>	240	42	590	010520024	<del>37,50 €</del> <b>22,00 €</b>
<b>1052/300</b>	300	55	900	010520030	<del>62,00 €</del> <b>36,00 €</b>



**1768**

017680010

**Aluminium footboard**



L mm	L1 mm	H mm
960	300	475



~~221,50 €~~  
**129,00 €**

**3009**

030090001

**Wheel lifter**

Maximum lifting capacity: 550 kg

- 4 pivoting rollers
- Roller width: 200 mm
- For wheels up to 240 mm in width

**IDEAL FOR:**

- **LOADING DAMAGED CARS ONTO TOW TRUCKS**
- **CAR REPAIR GARAGES**
- **MOVING CARS IN SHOWROOMS**



~~497,00 €~~  
**286,00 €**

**1766**

017660001

**Double suction lifter**



~~142,00 €~~  
**76,00 €**

**1367/K10**

013670200

**Kit of punches for installing parking sensors**

**Perpendicular, burr-free holes**

Sizes Kit contents:  
17 - 18 - 18,2 - 19 - 20 - 22,5  
- 24 - 26 - 26,7 - 32 mm



~~211,00 €~~  
**120,00 €**

**1479**

014790001

29,50 €  
**17,00 €**

**Trim pin remover**

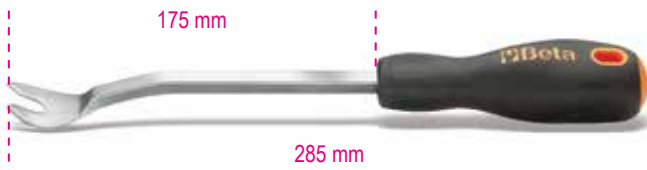

**1479LB/C5**

014790150

126,00 €  
**73,00 €**

**Kit of 5 metal trim pin removers**

215x165x50 mm



**1478/K3**

014780160

121,50 €  
**70,00 €**

**Pin removing pliers kit with plastic clips assortment**

Kit contents:

- flat nose pliers (1 pc.)
- 90° bent nose pliers (1 pc.)
- 625 plastic clips in 16 different sizes
- clips in 3 stackable PPL containers



L mm	L1 mm
180	170

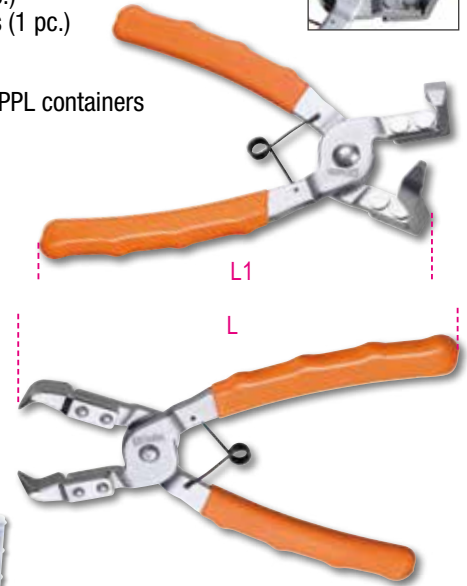

**1365/K13**

013650013

925,00 €  
**525,00 €**

**Oil pressure pump, 10 t, and bodywork accessories kit in handy trolley**

Kit contents:

- Oil pressure pump, 10 t, with 1.5-m-long hose, 1/2" coupling
- Piston
- Wing opening pliers; capacity: 500 kg
- Baseplate, 150x90 mm
- L-shaped base, 50x50 mm
- 4-point punch
- Round, knurled punch, Ø 50 mm
- Wedge-shaped punch, 43 mm
- 170-mm-long extension
- 300-mm-long extension
- 400-mm-long extension
- 530-mm-long extension
- Rubber head
- Male-to-male coupling for installing accessories

33 kg

**HANDY TROLLEY**

900x420x180 mm



**1361/K9**

013610030

355,00 €  
**202,00 €**

**Kit of 8 levers for bodywork dent pullers**

Kit contents:

- Round ball head rod, Ø 31 mm, length 110 cm
- Tip rod, length 62 cm
- Whale tail tip rod, length 112 cm
- Hook tip rod, length 27 cm
- Flat round head rod, length 50 cm
- Round ball head rod, Ø 19 mm, length 52 cm
- Whale tail head rod, length 27 cm
- Round whale tail head rod, length, 28 cm
- Fabric bag with handles

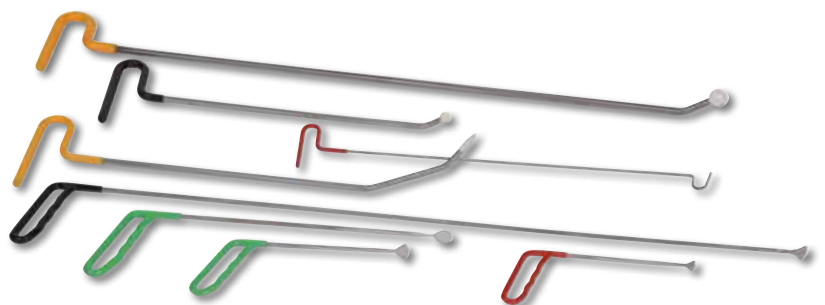

**1368**

013680001

~~494,00 €~~  
**285,00 €**

**Plastic repair kit**

- Power supply: 220÷240 V with Schuko socket
- Heat gun cable length: 3.5 m
- Power supply cable length: 1.35 m
- 2 power adjustments: 35-75 W
- Heat gun with brass terminals, 2 staple insertion angles: 0°-90°
- Input protection: thermal circuit breaker
- Output protection: 10 A fuse
- Metal gun pocket

**ALLOWS CRACKED AND BROKEN PLASTIC PARTS TO BE QUICKLY FIXED**



**1366SH**

013660400

~~2.330,00 €~~  
**1.299,00 €**

**Multifunction bodywork spotter**

- Microprocessor for managing welding parameters
- Contact and manual welding cycle start
- Automatic spot welding time setting function
- Supplied with quick coupling gun and 2.2-m-long ground cable

Accessory kit contents:

- extractor hammer
- three-pointed washer head
- 10 three-pointed washers
- carbon electrode
- squashing electrode



23 kg



Power supply	230V
50% power	2.5 KVA
Power peak	13 KVA
Amp output	2850 (2%) A
Max. Amp output	3200 A



**2254K**

022540101

~~34,00 €~~  
**20,00 €**

**Reusable seat, steering wheel and gear knob protector**



**2254F**

022540150

~~99,50 €~~  
**54,00 €**

**Car front protector**

Allows front part of vehicle to be protected, while leaving openings for headlights and radiator



**1479/B27**

014790407

~~92,50 €~~  
**50,00 €**

**Kit of 27 nylon tools for removing pins and working on plastics and seals, hangable**





## 1870I

018700220

301,00 €  
164,00 €

### Solid and fluid vacuum cleaner, 20 l, stainless steel drum

- Single-stage by-pass motor
- Voltage: 220/240 V
- Frequency: 50/60 Hz
- Max. power: 1200 W
- Airflow rate: 58 l/sec.
- Max. suction pressure: 190 mbar
- Max. drum capacity: 20 l, made of stainless steel
- Acoustic emissions: <70 dB(A)
- Cable length: 5 m

#### Standard accessories Ø 36 mm

- 1 corrugated hose with ergonomic handle and vent
- 2 hard extension tubes
- 1 multiuse brush for floors and fluids
- 1 flat nozzle
- 1 paper bag



#### Filtering systems

- 1 surface air filter cartridge 1900 cm<sup>2</sup> - 12 µm nom.
- 1 anti-foam filter PPI 45/PPI 30



IPX4



## 1875LT

018750000

662,00 €  
390,00 €

### Injection/extraction carpet/upholstery cleaner

Ideal for deeply cleaning textile surfaces. It dispenses pressure sprayed detergent and sucks it up with dirt, leaving surfaces almost dry.



### HIGHLY EFFECTIVE FOR CAR SEATS AND INTERIORS

#### Technical data:

- Voltage: 230/240 V
- Frequency: 50/60 Hz
- Max. power: 1100 W
- Airflow rate: 58 l/sec.
- Max. drum capacity: 20 l
- Max. detergent tank capacity: 3 l
- Max. pump pressure: 7 bar
- Max. suction pressure: 21 kPa
- Pump power: 48 W

#### Supplied accessories:

- 1 hose complete with ergonomic handle
- 1 dispenser unit
- 2 hard extensions
- 1 small spray extraction nozzle
- 1 big spray extraction nozzle
- 6 power cord locknuts



## 1874 50

018740050

994,00 €  
549,00 €

### Solid and fluid vacuum cleaner, 50 l, stainless steel drum

- Two-stage by-pass motor
- Voltage: 220/240 V
- Frequency: 50/60 Hz
- Max. power: 1350 W
- Airflow rate: 55 l/sec.
- Max. suction power: 240 mbar
- Max. drum capacity: 50 l, made of stainless steel
- Acoustic emissions: <63 dB(A)
- Cable length: 6 m
- Trolley for accessories

#### FILTERING SYSTEMS

- 1 filter paper bag
- 1 surface filter cartridge 5200 cm<sup>2</sup>, 12 µm nom.
- 1 anti-foam filter PPI 45/PPI 30

#### STANDARD ACCESSORIES, Ø 45 mm

- 1 corrugated hose with ergonomic handle
- 2 stainless steel extension tubes
- 1 industrial brush frame
- 1 industrial section for carpets
- 1 industrial section with fluid collection hoses
- 1 flat nozzle



**1898/C** **NEW**  
 018980940 ~~286,00 €~~  
**175,00 €**

**Wheeled sprayer, 25 l**

- Dual function: spraying and foaming
- Painted steel tank
- Stainless steel nozzle
- Anti-twisting hose
- Tank pressure gauge
- Tank level indicator



**Technical data:**

- Tank capacity: 25
- Supply hose length: 5 m
- Maximum working pressure: 4-5 bar
- Nozzle length: 0.65 m
- Maximum tank pressure: 8 bar

**1898/M**  
 018980930 ~~17,70 €~~  
**11,00 €**

**Pressure sprayer with 1,5 l tank**

- Adjustable nozzle with straight jet and mist spray
- Graduated scale 0.5 l - 1 l - 1.5 l
- Locking lever for continuous jet
- Not for use with hydrocarbons



**3003C**  
 030030100 ~~282,00 €~~  
**153,00 €**

**Creepers made of shockproof plastic**

Complete with:

- Head and lumbar region with carbon look finish
- Upper metal plates for fixing magnetic accessories
- 6 rubber castors, 79 mm in diameter



120 kg

5,5 kg

79 mm

**1898/S**  
 018980932 ~~31,00 €~~  
**19,00 €**

**Hand pressure pump with 5 l tank**

- Stainless steel nozzle
- Locking lever for continuous jet
- Adjustable nozzle with straight jet and mist spray
- Shoulder strap for ease of transport
- Nozzle hook-up handle
- 1.2-m-long hose
- Not for use with hydrocarbons



**2251N**  
 022510012 ~~170,50 €~~  
**98,00 €**

**Adjustable swivel creeper seat with tool drawers**

- Vertically adjustable seat (445 ÷ 580 mm)
- Square tool chest (380 mm) with 2 drawers (2+1)
- Drawer dimensions: 350x180x90 mm
- Tote-tray dimensions: 2X 190x190mm - 1X 380x190mm
- 4 pivoting castors, Ø 75 mm
- Weight: 11 Kg



**3002**  
 030020001 ~~133,50 €~~  
**77,00 €**

**Creepers and seat**

- Steel frame
- PVC lining with upholstery
- Easily convertible into a creeper or a seat
- Weight: 6,5 Kg



420 mm

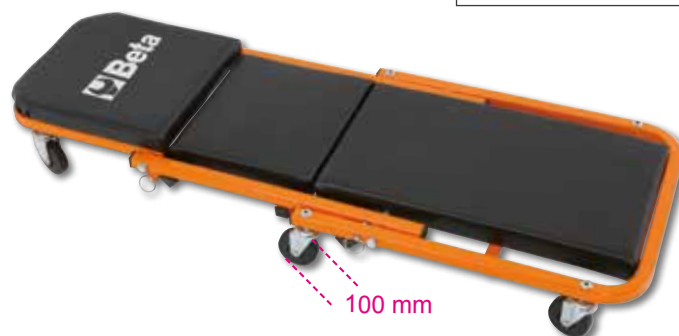

100 mm

## 3033E/3T

030330130

461,00 €  
279,00 €

### Hydraulic jack, 3 t

- Controlled descent speed
- Nylon wheels

H min-Max mm	L mm	L1 mm
95÷515	700	370



## 3029/2T

030290020

494,00 €  
285,00 €

### Lowered hydraulic jack, 2 t, with 4 wheels

- Quick approach pedal
- Steel frame and nylon wheels
- Minimum height: 75 mm

H min-Max mm	L mm	L1 mm
75÷500	720	290



## 3029L/2T

030290120

572,00 €  
329,00 €

### Long, lowered hydraulic jack, 2 t

Makes it possible to work on vehicles with a reduced height from the ground and internal lifting point.

Features:

- Controlled descent speed
- Quick approach pedal
- Nylon wheels

H min-Max mm	L mm	L1 mm
75÷520	930	295



## 3030/2T

030300020

939,00 €  
545,00 €

### Lowered hydraulic car jack, 2 t with 6 wheels

- Car jack can be easily handled on uneven, irregular floors
- Dual front tilting wheels made of plastic material (PTFE)
- Pedal allows easy approach

H min-Max mm	L mm	L1 mm
85÷520	860	400





**3030H/2T**

030300220

787,00 €  
**455,00 €**

**High-lift hydraulic jack, 2 t, with 6 wheels**

Makes it possible to work on vehicles that are high from the ground and have a long shock absorber travel

- Controlled descent speed
- Quick approach pedal
- Nylon wheels

H min-Max mm	L mm	L1 mm
85÷780	1010	300



**3033/3T**

030330030

1.245,00 €  
**714,00 €**

**Hydraulic jack, 3 t long version**

- Particularly suitable for use on commercial vehicles
- Polyamide wheels

H min-Max mm	L mm	L1 mm
140÷520	1180	370



**3065/40-20T**

030650200

3.500,00 €  
**1.969,00 €**

**Air hydraulic jack, 40/20 tons**

- Suitable for use on heavy vehicles
- Functional and easy to handle, for transportation on mobile repair shops as well
- Automatic piston return
- Two descent valves with under load speed control

H min-Max mm	L mm	L1 mm
150÷300	525	300



**40-20 t**



**3067/60-15T**

030670120

5.160,00 €  
**2.899,00 €**

**Air hydraulic jack, 60-30-15 t**

- Automatic piston return
- Two descent valves with under load speed control
- Supplied with two extensions, 70 and 120 mm long
- Include due prolunghe da 70 e 120 mm
- Power supply pressure: 8-10 bar
- Air consumption: 600 l/min

H min-Max mm	L mm	L1 mm
120÷255	660	250

**60-30-15 t**



**NEW**

**3023**

030230050

248,50 €  
**146,00 €**

*Pit and under bridge jack with screw adjustment*

**MAXIMUM CARRYING CAPACITY: 350 KG**

H min-Max mm	Ø mm
1350÷2030	300



**3011T**

*Hydraulic bottle jack*



	C max kg	H min+max mm		€
<b>3011T 2</b>	2000	174÷369	030110020	<del>104,50 €</del> <b>55,50 €</b>
<b>3011T 3,5</b>	3000	170÷366	030110035	<del>117,00 €</del> <b>61,00 €</b>
<b>3011T 5</b>	6000	203÷467	030110050	<del>131,50 €</del> <b>72,00 €</b>
<b>3011T 10</b>	10000	220÷484	030110100	<del>197,00 €</del> <b>105,00 €</b>
<b>3011T 15</b>	15000	230÷497	030110150	<del>241,00 €</del> <b>132,00 €</b>
<b>3011T 20</b>	20000	245÷521	030110200	<del>303,00 €</del> <b>175,00 €</b>
<b>3011T 32</b>	32000	260÷420	030110320	<del>314,00 €</del> <b>186,00 €</b>
<b>3011T 50</b>	50000	280÷450	030110500	<del>363,00 €</del> <b>219,00 €</b>

**3010T**

*Jack stands, pair*

	C max kg	H min+max mm		€
<b>3010T 2</b>	2000	280÷425	030100002	<del>117,00 €</del> <b>65,00 €</b>
<b>3010T 3</b>	3000	285÷430	030100003	<del>139,00 €</del> <b>76,00 €</b>
<b>3010T 6</b>	6000	400÷580	030100006	<del>202,00 €</del> <b>109,00 €</b>
<b>3010T 10</b>	10000	471÷735	030100010	<del>348,00 €</del> <b>189,00 €</b>



3010T 2  
3010T 3  
3010T 6



**3010H**

*Heavy-duty jack*

	C max kg	H min+max mm	L / L1 mm	i		€
<b>3010H631-T15</b>	15,000	445÷631	300x300	22,5	030100150	<del>376,00 €</del> <b>215,00 €</b>
<b>3010H1077-T15</b>	15,000	645÷1077	300x300	30	030100165	<del>472,00 €</del> <b>265,00 €</b>



**3010V**

*Heavy-duty jack stands, screw adjustable*

	C max kg	H min+max mm	L / L1 mm		€
<b>3010V600-T20</b>	20,000	410÷600	330x330	030100200	<del>548,00 €</del> <b>305,00 €</b>
<b>3010V1090-T20</b>	20,000	665÷1090	460x460	030100220	<del>696,00 €</del> <b>395,00 €</b>



# 3028

## HYDRAULIC PRESS WITH MOVING PISTON

**15 t**

 850 mm  
480 mm  
678 mm

57 kg

**3028 15**

030280015

 1.220,00 €  
703,00 €

	3028 15	3028 20	3028 30	3028 50
Maximum capacity	15 t	20 t	30 t	50 t
Single speed pump	✓	✓	✓	✓
Moving piston	✓	✓	✓	✓
Hydraulic safety in case of overloading	✓	✓	✓	✓
Gauge	✓	✓	✓	✓
Set of V-shaped prisms	✓	✓	✓	✓
Hoist	X	X	X	✓

**20 t**

 1830 mm  
540 mm  
850 mm

98 kg

**3028 20**

030280020

 1.775,00 €  
1.022,00 €

**30 t**

 1850 mm  
540 mm  
850 mm

132 kg

**3028 30**

030280030

 2.475,00 €  
1.418,00 €

**50 t**

 1850 mm  
650 mm  
1100 mm

241 kg

**3028 50**

030280050

 4.330,00 €  
2.497,00 €

**3028/KP**

030280055

 154,00 €  
88,00 €

### Kit of pin punches and plate for presses 3028

Sizes of pin punches:

- Ø10X90mm
- Ø12X90mm
- Ø16X90mm
- Ø18X115mm
- Ø20X115mm
- Ø22X115mm
- Ø25X140mm
- Ø30X140mm

**3027PR/N**

030270410

**NEW**

 319,00 €  
182,00 €

### Press supporting tool for removal/insertion of hubs, bearings and silent blocks

Universal device allowing user to install/remove hubs, bearings and silent blocks into/from their housings by operating via a press, through a supporting base and dedicated accessories. Designed to adapt to irregular geometric shapes of hubs/king pins on which operator must work. Can be used with presses 3027N and 3028.

Technical data:

- Working range: min. 135 mm - max. 150 mm
- Maximum load bearing capacity: 20 t





**3006**

030060000

~~2.110,00 €~~  
**1.098,00 €**

**Jack and positioner for tractor and excavator wheels**

- Max. capacity: 1,500 kg
- Min. wheel diameter: 1,000 mm
- Max. wheel diameter: 2,200 mm
- Max. wheel thickness: 800 mm



**3026**



**Hydraulic pit and under bridge jack**

**3026 0,3**

030260003

~~812,00 €~~  
**439,00 €**

24,7 kg

**3026 0,5**

030260005

~~966,00 €~~  
**495,00 €**

31 kg

**3026 1,0**

030260010

~~1.166,00 €~~  
**582,00 €**

37,8 kg



**3026 0,3    3026 0,5    3026 1,0**

Maximum capacity	300 kg	500 kg	1000 kg
Pedal pump	✓	✓	✓
Minimum height	1120 ÷ 1970 mm	1140 ÷ 1990 mm	1140 ÷ 1990 mm
Load limiting valve	✓	✓	✓

**3014SAR**

030140360

~~1.650,00 €~~  
**945,00 €**

**Folding engine stand**

- Easy to fold up, for significantly increased compactness
- Allows 360° rotation of engine or gear
- Provides unparalleled safety and stability during jobs



**MAXIMUM CAPACITY: 450 KG**

**3026/SP**

030260505

~~799,00 €~~  
**384,00 €**

**Universal transmission support**

- Allows one operator to disassemble and reassemble any transmissions of cars, commercial vehicles and off-roaders quickly and safely
- Suitable for stands with diameter: 25-30-35-45 mm
- Max. capacity: 150 kg
- Height: 250 mm



**1889N**

018890220

~~938,00 €~~  
**384,00 €**

**Steel handling and storage base for 2 200-l barrels**

- Easy to carry with a fork lift truck or a pallet jack
- Support cannot be placed under any part
- Completely hot painted with epoxy powder, for high resistance to chemicals



**3025N 1,0**

030250110

2.550,00 €  
**1.276,00 €**

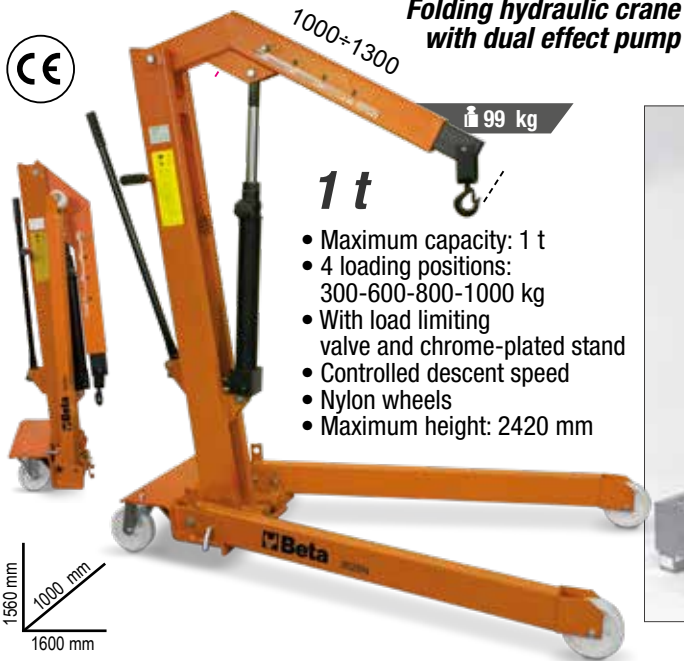

**Folding hydraulic crane with dual effect pump**

**1 t**

- Maximum capacity: 1 t
- 4 loading positions: 300-600-800-1000 kg
- With load limiting valve and chrome-plated stand
- Controlled descent speed
- Nylon wheels
- Maximum height: 2420 mm

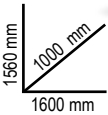

**3025N/PF**

030250111

557,00 €  
**318,00 €**



**Barrel handling pliers**

**Maximum capacity: 300 KG**

- Sturdy supporting pins for reliable performance over time
- Long jaws for secure, firm hold on several different types of barrels
- Maximum lifting capacity 300 kg

**Robur**

**8153**

**Lifting web slings, green 2t two layers with reinforced eyes high-tenacity polyester (PES) belt EN 1492-1**

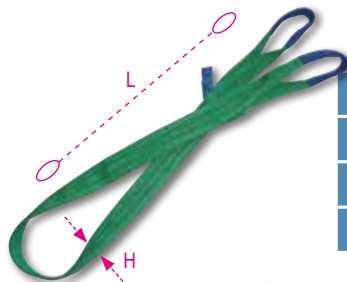

- Lifting web slings
- Two layers with reinforced eyes
- High-tenacity polyester (PES) belt



	L m	H mm		€
<b>8153 1-T2</b>	1	60	081530010	<del>10,40 €</del> <b>6,50 €</b>
<b>8153 2-T2</b>	2	60	081530020	<del>16,10 €</del> <b>9,50 €</b>
<b>8153 3-T2</b>	3	60	081530030	<del>21,90 €</del> <b>13,00 €</b>
<b>8153 4-T2</b>	4	60	081530040	<del>27,00 €</del> <b>17,00 €</b>

**8156**

**Lifting web slings, yellow 3t two layers with reinforced eyes high-tenacity polyester (PES) belt EN 1492-1**

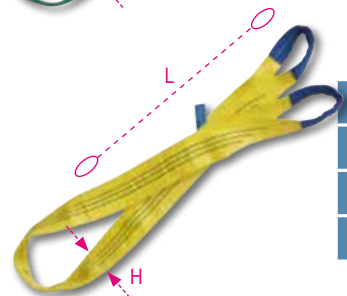

	L m	H mm		€
<b>8156 2-T3</b>	2	90	081560020	<del>24,10 €</del> <b>15,00 €</b>
<b>8156 3-T3</b>	3	90	081560030	<del>33,50 €</del> <b>20,00 €</b>
<b>8156 4-T3</b>	4	90	081560040	<del>41,50 €</del> <b>25,00 €</b>
<b>8156 6-T3</b>	6	90	081560060	<del>58,50 €</del> <b>35,00 €</b>

**8181 6/B4**

081810916

82,50 €  
**44,00 €**

**Bag with set of 4 ratchet tie-downs 8181, 6 m high-tenacity polyester belt, single hooks**  
The bag includes 4 ratchet tie-downs with single hooks, high-tenacity polyester belt (PES), 35 mm, 6 m long.



L m	LC kg
6	1000



EN 12195-2

**8182 8,5/B2**

081821885

72,50 €  
**38,00 €**

**Bag with set of 2 ratchet tie-downs 8182, 8.5 m high-tenacity polyester belt, single hooks**  
The bag includes 2 ratchet-downs with single hooks, high-tenacity polyester belt (PES), 50 mm, 8.5 m long.



L m	LC kg
8,5	2000



EN 12195-2

## 3050/600

~~6.290,00 €~~  
3.349,00 €

### Electro-hydraulic motorcycle jack, 600 kg

- Electrical, mechanical and hydraulic safety devices
- Capacity: 600 kg
- Integrated electro-hydraulic unit: 230V - 50 Hz
- Hydraulic pump
- Controlled downward speed
- Safety fuses for protection in case of cable cuts
- Control push button panel
- CE-certified, TÜV-approved

Ral 2011	Ral 7016	Ral 3000
030500201	030500202	030500203

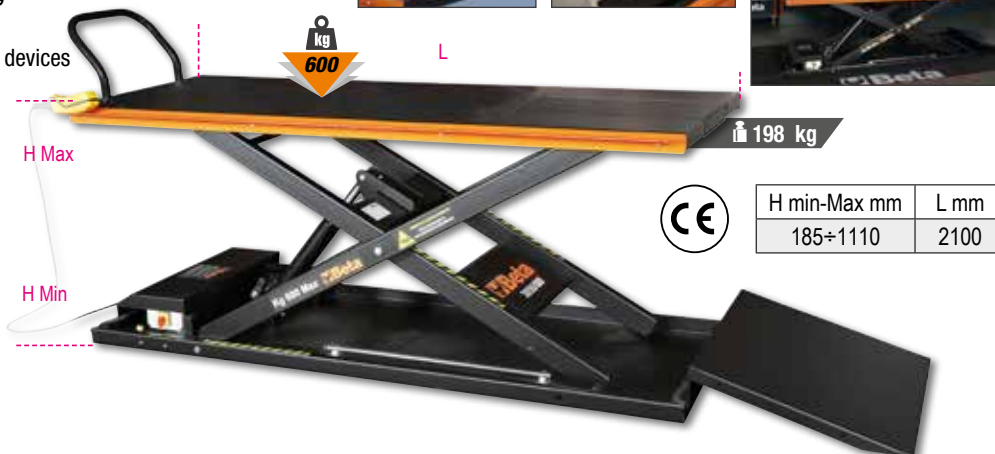

## 3040C

030400002

~~93,00 €~~  
54,00 €

### Rear motorcycle stand, adjustable

- Includes V-shaped sliders, pair
- Includes L-shaped sliders, pair



- Matt black lacquer
- 4 thermoplastic rubber wheels

## 3041C

030410002

~~87,00 €~~  
51,00 €

### Front motorcycle stand, adjustable

- Includes roller sliders, pair
- Includes cone-shaped sliders, pair



## 2002/B27 SBK

020020927

~~341,00 €~~  
164,00 €

27

### Travelling kit for motorbikers

Tool kit suitable for travelling in all safety

595X540 mm



2,8 kg

#### Quantity/Description

- 8 Double open end wrenches 6x7-8x9-10x11-12x13-14x15-16x17-18x19-20x22 mm
- 9 offset hexagon key wrenches 1,5-2-2,5-3-4-5-6-8-10 mm
- 3 Evox screwdrivers for slotted head screws 3,5x100-5,5x150-6,5x150 mm
- 2 Evox screwdrivers for cross head Phillips® screws 4,5x80 - 6x100 mm
- 1 Multipurpose tool complete with bits and sheath
- 1 LED inspection torch 133 mm
- 1 Instant glue for structural joints 5 gr
- 1 PVC electrical tape sp.0,15 mm / 19 mm x 25 m
- 50 Nylon cable ties 4,8x300 mm
- 1 Roll-up tool wallet made of durable polyester, empty

- Beta N.
- 55
  - 96BPC/SC9
  - 1201E
  - 1202E
  - 1778MT
  - 1833 XS/2
  - 9851
  - BMESB1925NE
  - BMN3048
  - 2002/BV42

## 3043C

030430002

~~114,50 €~~  
65,00 €

### Motorcycle stand with left single arm

- Matt black lacquer
- 4 thermoplastic rubber wheels
- Optional pin





**3910**

039100010

4,150,00 €  
**2.199,00 €**

**E-Bike lift**

- Maximum height of central movement support: 135 cm
- Built-in wheel truing stand
- Innovative thru-axle locking system
- Supplied with adapter sockets for most forks
- Supplied with fork connection adapter without thru-axle
- Fully foldable and transportable
- Lift weight: 48kg

H min-Max mm	L mm
600÷1350	80



**3912PP**

039120150

998,00 €  
**571,00 €**

**PRO workshop workbench for bicycle maintenance**

- With support for central movement, with safety pin
- Built-in wheel truing stand
- Innovative thru-axle locking system

H min-Max mm	L mm
590÷1000	455



**3916MMP**

039160150

847,00 €  
**485,00 €**

**Workshop single-sided clamp for bicycle maintenance**

- Clamp can be rotated 360°, with floating jaws and micrometric adjustment
- Plastic tool tray



H min-Max mm
1230÷1380

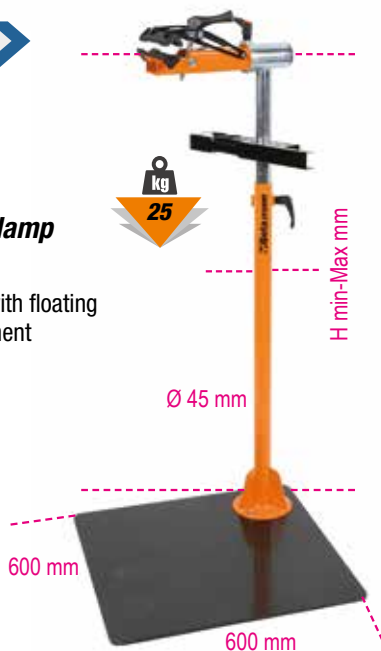

**3965C**

039650110

458,00 €  
**263,00 €**

**Professional wheel truing stand**

- Can be fixed onto both a workbench, with supplied clamps, and into a vice
- For  $\varnothing 20'' \div 29''$
- Through axle hub adapter, 10 ÷ 20 mm
- Can be used with hub spacings ranging from 85 mm to 195 mm



**605BC/15**

006050015

**NEW**

242,00 €  
**138,00 €**

**Click-type torque wrench with reversible ratchet, for right-hand tightening, compact, made from aluminium, torque accuracy:  $\pm 4\%$**

**14" 72**

- Accuracy:  $\pm 4\%$ , right-hand
- Reversible ratchet, 72 teeth
- Right-hand tightening
- 1/4" square drive
- Unit of measurement: Nm
- Compact: no more than 17.5 cm



The smallest torque wrench of Beta's range: compact and easy to use, it provides an ideal combination of convenience and simplicity within reach.

Nm	kgfm	lbf.fn	■	L (mm)	LLLLL
3÷15	0,3÷1,5	26÷133	1/4"	175	0,1



# THE REVOLUTIONARY IMPACT WRENCH

**NEW**

**THAT DOES NOT  
REQUIRE LUBRICATION**

The impact wrench, 19270LS, fully designed, developed and engineered by Beta Utensili, relies on the **OIL-LESS** system, a brand-new innovation in the pneumatic tool industry: it allows the impact wrench to operate without having to be periodically lubricated with oil, thus ensuring increased durability and high performance.

The painstakingly studied assembly, micrometer alignment of the interior parts and use of innovative first-rate materials result in a reduced number of failures, for lubrication-free lifetime use.

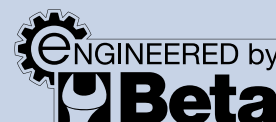

Balanced and powerful, with unparalleled service life

Three power adjustable screwing positions

2,5 kg

Vibration free handle



Exhaust through handle

## PATENT PENDING

The **OIL-LESS** impact wrench stands out for high torque transmission – that is, 1750 Nm –, which makes it ideal for any application.



**NEW**

**19270LS**

019270010

803,00 €  
**439,00 €**

- No lubrication required
- Double hammer impulse device

Free speed	8.000 rpm
Max. torque	1.750 Nm
Bolt capacity	Cl 8.8 M24●36 mm
Bolt capacity	Cl 12.9 M20●30 mm
Air inlet	1/4" GAS
Operating pressure	6,2 bar
Internal hose size (Ø)	10 mm
Mean air consumption	198 l/min

**4 TIMES** THE USEFUL LIFE  
OF A TRADITIONAL IMPACT WRENCH

Based on these hallmarks, the **OIL-LESS** impact wrench can boast an excellent cost/benefit ratio, thus translating into savings in the long run.

## 1927P

019270008

### Reversible impact wrench

- Double hammer impulse device
- Lightweight and well-balanced for enhanced ease of use
- Reversible lever
- Three power adjustable screwing positions
- Exhaust through handle
- Vibration-damping handle

**1750 Nm**

Free speed	rpm	7.500
Impulse device		Double hammer
Max. torque	Nm	1750
Bolt capacity	Cl 8.8	M24●36 mm
Bolt capacity	Cl 12.9	M20●30 mm
Air inlet	GAS	1/4"
Operating pressure	bar	6,2
Internal hose size (Ø)	mm	10
Mean air consumption	l/min	290

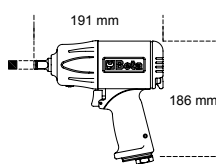
 495,00 €  
**219,00 €**

## 1927P/K3

019270118

 647,00 €  
**241,00 €**

Reversible impact wrench,  
supplied with 3 impact sockets,  
in plastic case



4 kg

 720 LC  
 17-19-21 mm

350x305x86 mm

## 1927XM

019270030

### Compact reversible impact wrench

- Single hammer impulse device
- Amazingly compact and powerful
- One-hand reverse button
- Three power adjustable screwing positions
- Exhaust through handle
- Balancing hook

Free speed	rpm	10.000
Impulse device		Single hammer
Max. torque	Nm	770
Bolt capacity	Cl 8.8	M22●34 mm
Bolt capacity	Cl 12.9	M18●27 mm
Air inlet	GAS	1/4"
Operating pressure	bar	6,2
Internal hose size (Ø)	mm	10
Mean air consumption	l/min	122

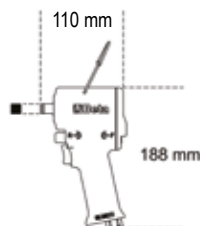
 308,00 €  
**164,00 €**

## 1927XM/K5

019270129

 380,00 €  
**197,00 €**

Assortment of 1 compact reversible  
impact wrench and 5 impact sockets,  
in plastic case

720 17-19-21-22-24 mm



2,8 kg

307x206x86 mm





**NEW**

**1927E**

019270005

154,00 €  
**87,00 €**

**Reversible impact wrench,  
made from composite material**



- Double hammer impulse device
- Reverse control knob
- Three power adjustable screwing positions
- Exhaust through handle
- Vibration-damping handle

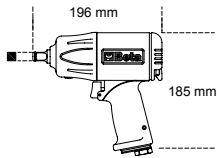

Free speed	rpm	7.000
Impulse device		Double hammer
Max. torque	Nm	750
Bolt capacity	Cl 8.8	M22●36 mm
Bolt capacity	Cl 12.9	M18●30 mm
Air inlet	GAS	1/4"
Operating pressure	bar	6,2
Internal hose size (Ø)	mm	10
Mean air consumption	l/min	140

**NEW**

**1927C**

019270006

259,00 €  
**142,00 €**

**Reversible impact wrench,  
made from composite material**



- Double hammer impulse device
- Lightweight and well-balanced, for enhanced ease of use
- Reverse control lever
- Three power adjustable screwing positions
- Exhaust through handle
- Vibration-damping handle

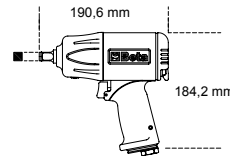

Free speed	rpm	9.000
Impulse device		Double hammer
Max. torque	Nm	950
Bolt capacity	Cl 8.8	M22●34 mm
Bolt capacity	Cl 12.9	M18●27 mm
Air inlet	GAS	1/4"
Operating pressure	bar	6,2
Internal hose size (Ø)	mm	10
Mean air consumption	l/min	125

**1928XM**

019280030

659,00 €  
**373,00 €**

**Compact reversible impact wrench**

- Double hammer impulse device
- Amazingly compact and powerful
- One-hand reverse button
- Three power adjustable screwing positions
- Exhaust through handle



**ULTRA COMPACT  
AND POWERFUL**



**1600 Nm**

Free speed	rpm	4.800
Impulse device		Double hammer
Max. torque	Nm	1600
Bolt capacity	Cl 8.8	M27●41 mm
Bolt capacity	Cl 12.9	M24●36 mm
Air inlet	GAS	3/8"
Operating pressure	bar	6,2
Internal hose size (Ø)	mm	10
Mean air consumption	l/min	175

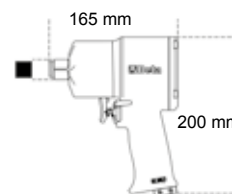

## 1928DA

019280022

 952,00 €  
**439,00 €**

### Reversible impact wrench

- Double hammer impulse device
- Sturdy and compact; high torque
- Reversible lever
- Three power adjustable positions
- Exhaust through handle
- Slip-proof ergonomic handle

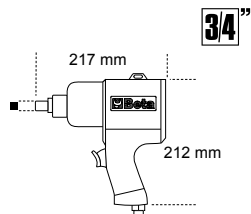

4,3 kg

Free speed	rpm	5.000
Impulse device		Double hammer
Max. torque	Nm	1695
Bolt capacity	Cl 8.8	M30●46 mm
Bolt capacity	Cl 12.9	M27●41 mm
Air inlet	GAS	3/8"
Operating pressure	bar	6,2
Internal hose size (Ø)	mm	10
Mean air consumption	l/min	210

## 1928P

019280006

 1.310,00 €  
**604,00 €**

### Reversible impact wrench, made from composite material

- Double hammer impulse device
- Lightweight and well-balanced for enhanced ease of use
- Reversible lever
- Three power adjustable screwing positions
- Exhaust through handle
- Vibration-damping handle

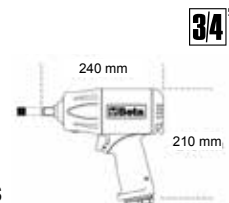

## 2100 Nm



3,7 kg

### ULTRA COMPACT AND POWERFUL

Free speed	rpm	5.000
Impulse device		Double hammer
Max. torque	Nm	2100
Bolt capacity	Cl 8.8	M30●46 mm
Bolt capacity	Cl 12.9	M27●41 mm
Air inlet	GAS	3/8"
Operating pressure	bar	6,2
Internal hose size (Ø)	mm	10
Mean air consumption	l/min	221

## 1930LH

019300030

 1.470,00 €  
**824,00 €**

### Reversible impact wrench

- Double hammer impulse device
- 210 mm (8.3") long anvil
- New 70-degree angled handle design to relieve stress and fatigue on the operator's wrists
- Auxiliary side handle
- 3 power adjustable screwing/unscrewing positions
- Lower exhaust
- Excellent weight/power ratio



7,1 kg

Free speed	rpm	6.000
Max. torque	Nm	2.441
Bolt capacity	Cl 8.8	M36●55 mm
Bolt capacity	Cl 12.9	M30●46 mm
Air inlet	GAS	1/2"
Operating pressure	bar	6,2
Internal hose size (Ø)	mm	13
Mean air consumption	l/min	280

## 1930PA

019300032

 1.420,00 €  
**769,00 €**

### Reversible impact wrench

- Double hammer impulse device
- Auxiliary handle
- Reversible lever
- Three power adjustable screwing/unscrewing positions
- Exhaust through handle

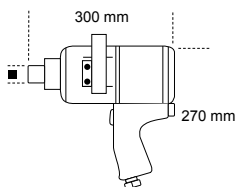

9,6 kg

Free speed	rpm	3.500
Impulse device		Double hammer
Max. torque	Nm	2445
Bolt capacity	Cl 8.8	M36●55 mm
Bolt capacity	Cl 12.9	M30●46 mm
Air inlet	GAS	1/2"
Operating pressure	bar	6,2
Internal hose size (Ø)	mm	13
Mean air consumption	l/min	350

### 720ME/C8

007200525

~~170,00 €~~  
98,00 €

8 impact socket drivers for hexagon screws

5-6-8-10-12-14-17-19 mm



270x120x45 mm



### 720TX/C6

007200483

~~139,00 €~~  
81,00 €

6 impact socket drivers for Torx® head screws



T30-T40-T45-T50-T55-T60



### 720/C24

007200904

~~464,00 €~~  
230,00 €

Set of 24 impact sockets, 1/2" female drive, phosphatized, in metal case



420x185x60 mm



	N°	Descrizione
	720	15 10-12-13-14-15-16-17-18 19-21-22-24-27-30-32 mm
	720L	6 13-17-19-21-22-24 mm
	720LC	3 17-19-21 mm

### 720/C12

007200912

~~217,50 €~~  
120,00 €

12 impact sockets



10-11-12-13-14-17-19-  
22-24-27-30-32 mm



195x80x55 mm

### 728/C10

007280910

~~390,00 €~~  
219,00 €

10 impact sockets



17-19-22-24-27-30  
-32-36-41-46 mm



275x120x65 mm



**HIGH TORQUE  
WITHOUT  
AFFECTING WRIST**
**Reversible air impact ratchets**

- Double rocking dog" impulse device
- Easy tightening: The impact mechanism system eliminates wrist twisting at end of screwing and shortens operating time
- Compact and powerful: maximum torque is significantly higher than maximum torque as achieved with a conventional ratchet
- Ergonomic rubber handle

**1922P1**

019220006

~~305,00 €~~  
**175,00 €**
**68 Nm**
**1/4"**

600 g



Free speed	rpm	700
Maximum torque	Nm	68
Bolt capacity	Cl 8.8	M10●16 mm
Bolt capacity	Cl 12.9	M8●13 mm
Air inlet	GAS	1/4"
Operating pressure	bar	6,2
Internal hose size (Ø)	mm	10
Mean air consumption	l/min	88

**1922P3**

019220013

~~481,00 €~~  
**274,00 €**
**136 Nm**
**1/2"**

1,5 Kg



Free speed	rpm	600
Maximum torque	Nm	136
Bolt capacity	Cl 8.8	M12●18 mm
Bolt capacity	Cl 12.9	M10●16 mm
Air inlet	GAS	1/4"
Operating pressure	bar	6,2
Internal hose size (Ø)	mm	10
Mean air consumption	l/min	113

**1937**

019370001

~~528,00 €~~  
**225,00 €**
**Roto-orbital palm sander, lubrication free, made from composite material**

- No lubrication required
- Extremely compact and easy to handle
- Orbit diameter: 5 mm
- 6-hole Velcro pad
- Continuous motor speed adjustment
- Nonslip, soft material handle
- Designed for connection to suction systems with swivel fittings
- Revolving exhaust

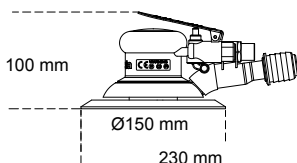

860 g

**Orbit Ø 5 mm**

Free speed	rpm	12.000
Power	kW	0,18
Pad size	mm	150
Spindle thread		5/16"-24
Air inlet	GAS	1/4"
Operating pressure	bar	6,2
Internal hose size (Ø)	mm	10
Mean air consumption	l/min	170

**1942A**

019420000

~~372,00 €~~  
**211,00 €**
**Air saw**

- Powerful and handy
- Designed for cutting bodies, exhaust pipes and silencers, aluminium and plastic
- Complete with rubber handle, PVC exhaust pipe and air-feeding hose
- Rear exhaust

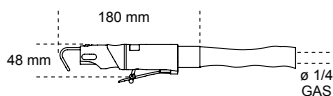

550 g

Strokes per minute		10.000
Stroke length	mm	10
Air inlet	GAS	1/4"
Operating pressure	bar	6,2
Internal hose size (Ø)	mm	8
Mean air consumption	l/min	75

**1952**

019520012

~~183,50 €~~  
**105,00 €**
**Professional paint spray gun**

- Die-cast aluminium body plated with black chemical nickel
- Nylon cup with drip-catching device, 3/8M BSP thread
- Body thread: 1/4" BSP cylindrical gas thread
- Pressure and airflow regulator
- Jet regulator from round to fan spray pattern
- Paint quantity regulator
- Supplied with service spanner for maintenance operations



	Ø mm	
<b>1952 1,2</b>	1,2	019520012
<b>1952 1,5</b>	1,5	019520015
<b>1952 1,8</b>	1,8	019520018
<b>1952 2,0</b>	2,0	019520020



# SAFETY FOOTWEAR AND WORKWEAR



EU	35	36	37	38	39	40	41	42	43	44	45	46	47	47
UK	2,5	3,5	4,5	5	6	6,5	7	8	9	10	10,5	11	12	13

**2025**  
**SPRING/SUMMER COLLECTION**





**RENEGADE**

**NEW**

**THE NEW SAFETY FOOTWEAR RANGE**

**Renegade has been designed to provide uncompromising safety and style.**

The range, which comprises 6 models in unique colours and materials, perfectly suits those interested in standing out in any working environment. Renegade relies on a design inspired by latest generation sports shoes, superior cushioning and remarkable support to provide comfort all day long.

**BASED ON A BOLD, UNCONVENTIONAL STYLE, Renegade is an ideal pick for modern professionals.**



**INNOVATIVE DESIGN**

**HIGHLY BREATHABLE**

**EVA OUTSOLE WITH DURABLE NITRILE RUBBER TREAD WIDE FIT**

**THE WIDE BODY**  
The wide body – 11 – ensures smooth, comfortable walks, without compressing the foot.

**QUICK LACING SYSTEM**

Model 7340VA is Beta's first shoe fitted with a quick lacing system.

**METAL FREE**  
composite fibre penetration-proof insole

**RENEGADE MATCHES PROTECTION WITH A CAPTIVATING, MODERN APPEARANCE.**

RENEGADE



**EN ISO 20345 2022**



**7340VA**

~~188,00 €~~  
**107,00 €**

*RENEGADE mesh fabric shoe, highly breathable, with ATOP lacing*

**Sizes available: from 37 to 48**

from 073400537 to 073400548

**S1PS FO SR HRO**



RENEGADE

METAL  
GO  
FREEEN ISO  
20345  
2022

NEW

7340G

153,00 €  
87,00 €*RENEGADE mesh fabric shoe, highly breathable, with traditional lacing*Sizes available: from 37 to 48  
from 073400637 to 073400648

S1PS FO SR HRO

7341V

160,50 €  
89,50 €*RENEGADE woven fabric, hard-wearing and breathable, green details*Sizes available: from 37 to 48  
from 073410537 to 073410548

S1PS FO SR HRO

7341Y

160,50 €  
89,50 €*RENEGADE woven fabric shoe, hard-wearing and breathable, yellow details*Sizes available: from 37 to 48  
from 073410637 to 073410648

S1PS FO SR HRO

7342N

170,50 €  
97,00 €*RENEGADE microfibre shoe, water-repellent*Sizes available: from 37 to 48  
from 073420537 to 073420548

S3S FO SR HRO

7343N

186,00 €  
105,00 €*RENEGADE microfibre ankle shoe, water-repellent*Sizes available: from 37 to 48  
from 073430537 to 073430548

S3S FO SR HRO

# FitEvolution

Seven uniquely designed models, available in several colours and materials, ranging from mesh to microfibre, to satisfy the most demanding users' requirements.

## THE PATENTED SYSTEM BETA FIT4YOU

TO CUSTOMIZE COMFORT  
IN THEIR SAFETY FOOTWEAR.

After several years of painstaking studying and designing, we developed the patented system, **FIT 4 YOU**. This state-of-the-art penetration-proof insole pressing process allows three different **ETPU** inserts – each with different densities – to be combined, to provide three levels of comfort, thus satisfying every user's requirements.

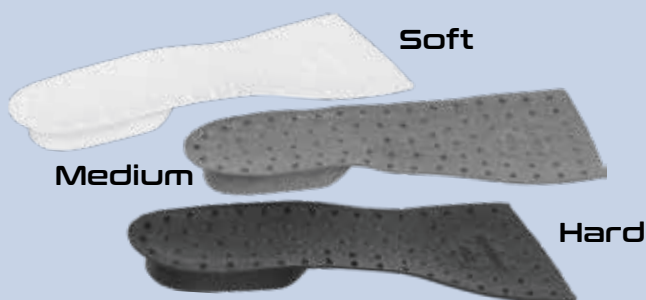

### ETPU Inserts

ETPU is the core of the FIT 4 YOU system, ensuring a cushioning effect and energy return. Based on three provided inserts varying in density and colour, it allows both softness and support to be customized in the shoe, according to weight, height and personal requirements. This groundbreaking technology ensures optimal comfort while moving as well as during static breaks, thereby resulting in reduced joint stress and fatigue.



The patented system, **FIT 4 YOU**, is based on **3 provided ETPU** inserts, varying in density and colour, to allow the user to customize the shoe according to weight, height and personal usage requirements.



- Composite toe cap
- Composite fibre penetration-proof insole
- 3 ETPU inserts, with 3 different densities, for a customized shoe
- Heel stability support and traditional lacing.
- Dual-density polyurethane outsole

7272V

163,00 €  
92,00 €

FitEvolution woven fabric shoe,  
hard-wearing and highly breathable

S1 PS FO SR ESD



Sizes available: from 37 to 48  
from 072720137 to 072720148

**7270Y**

~~163,00 €~~  
**92,00 €**

Fit**Evolution** mesh fabric shoe, highly breathable



**S1 PS FO SR ESD**



Sizes available: from 37 to 48

from 072700137 to 072700148

**7271V**

~~163,00 €~~  
**92,00 €**

Fit**Evolution** suede shoe, perforated



**S1 PS FO SR ESD**



Sizes available: from 37 to 48

from 072710137 to 072710148

**7273G**

~~167,00 €~~  
**95,00 €**

Fit**Evolution** nubuck shoe, water-repellent



**S3 S FO SR ESD**



Sizes available: from 37 to 48

from 072730137 to 072730148

**7274G**

~~172,50 €~~  
**98,00 €**

Fit**Evolution** nubuck ankle shoe, water-repellent



**S3 S FO SR ESD**



Sizes available: from 37 to 48

from 072740237 to 072740248

**7275N**

~~167,00 €~~  
**95,00 €**

Fit**Evolution** microfibre shoe, water-repellent

**S3 S FO SR ESD**



Sizes available: from 37 to 48

from 072750237 to 072750248





**EXTREMELY LIGHT**



**LESS THAN 500 G**  
APPROXIMATE WEIGHT FOR SIZE 42

**7352B**

~~145,00 €~~  
**82,00 €**

*O-Gravity mesh fabric shoe, highly breathable, with TPU inserts*

- Composite toe cap
- Stretch slip-on collar



450 g

**S1P HRO SRC**



Sizes available: from **38 to 48**  
from 073520138 to 073520148

**7352G**

~~158,00 €~~  
**85,00 €**

*O-Gravity ultralightweight mesh fabric shoe, highly breathable*

- Composite toe cap
- Traditional lacing
- Wide fit



450 g

**S1P HRO SRC ESD**



Sizes available: from **38 to 48**  
from 073520338 to 073520348

**ACTIVE**



**7317NA**

~~83,00 €~~  
**48,00 €**

*Suede shoe, perforated, with microfibre reinforcement in heel area*



**S1P SRC**

Sizes available: from **35 to 48**  
from 073170135 to 073170148

**7320NA**

~~87,50 €~~  
**49,00 €**

*Nubuck shoe, water-repellent, with anti-abrasion reinforcement in toe cap area*



**S3 SRC**

Sizes available: from **35 to 48**  
from 073200535 to 073200548

**FLEX**

**THE MOST FLEXIBLE**



**7212B**

~~81,50 €~~  
**43,00 €**

*Suede shoe, perforated, with mesh inserts. Anti-abrasion insert in toe cap area*



490 g

**S1P SRC ESD**



Sizes available: from **35 to 48**  
from 072120235 to 072120248

**7214G**

~~88,00 €~~  
**47,00 €**

*Action nubuck shoe, water-repellent, with anti-abrasion insert in toe cap area*



500 g

**S3 SRC ESD**



Sizes available: from **35 to 48**  
from 072140235 to 072140248

# NEW LOOK!



**7982N**

079820000

~~10,90 €~~  
**6,50 €**

**Curved visor Cap,**  
100% polyester, strap closure black



**7643G**

**NEW**

~~53,50 €~~  
**29,80 €**

**Sweatshirt**

- Short-zipped, 80% cotton, 20% polyester, 280 g/m<sup>2</sup>, a anthracite/light grey



	XS	S	M	L	XL	2XL	3XL
	076430000	076430001	076430002	076430003	076430004	076430005	076430006

**7820SG**

**NEW**

~~68,00 €~~  
**39,00 €**

**Stretch work trousers,**  
multipocket style

- 39% cotton, 61% polyester
- **Mechanical stretch ripstop** fabric, 170 g/m<sup>2</sup>
- GreyKnee
- Pad pockets and stretch waistband on sides
- Regular fit



	XS   46	S   48	M   50	L   52	XL   54	2XL   56	3XL   58
	078200100	078200101	078200102	078200103	078200104	078200105	078200106

**7821SG**

**NEW**

~~53,50 €~~  
**29,80 €**

**Stretch work Bermuda shorts**

- Multipocket style, 39% cotton, 61% polyester,
- **Mechanical stretch ripstop** fabric, 170 g/m<sup>2</sup>,
- Stretch waistband on sides
- Regular fit



	XS   46	S   48	M   50	L   52	XL   54	2XL   56	3XL   58
	078210100	078210101	078210102	078210103	078210104	078210105	078210106

**NEW**

**7340VA**

Renegade 80



7642G

35,00 €  
20,00 €

Crew-neck sweatshirt

- 60% cotton, 40% polyester, 240 g/m<sup>2</sup>



	XS	S	M	L	XL	2XL	3XL
	076420000	076420001	076420002	076420003	076420004	076420005	076420006

7660

88,50 €  
48,00 €

Stretch work trousers, lightweight, multipocket style

- 86% nylon - 14% spandex, 140 g/m<sup>2</sup>, anthracite grey
- Knee pad pockets, rear pockets reinforced in polyester 300D, tearproof crotch
- Slim fit



SLIM FIT



	XS   46	S   48	M   50	L   52	XL   54	2XL   56	3XL   58
7660B	076600100	076600101	076600102	076600103	076600104	076600105	076600106
7660G	076600000	076600001	076600002	076600003	076600004	076600005	076600006

**NEW**  
7275N  
Renegade 83

7661

77,00 €  
42,00 €

Stretch work Bermuda shorts, lightweight, multipocket style

- 86% nylon - 14% spandex, 140 g/m<sup>2</sup>, anthracite grey



	XS   46	S   48	M   50	L   52	XL   54	2XL   56	3XL   58
7661G	076610000	076610001	076610002	076610003	076610004	076610005	076610006
7661B	076610100	076610101	076610102	076610103	076610104	076610105	076610106



SLIM FIT



# 7553

**NEW**

~~13,80 €~~  
**7,50 €**

Work t-shirt made from jersey cotton,  
150 g/m<sup>2</sup>

**100% COTTON**



	XS	S	M	L	XL	2XL	3XL
<b>7553BL</b>	075530300	075530301	075530302	075530303	075530304	075530305	075530306
<b>7553G</b>	075530400	075530401	075530402	075530403	075530404	075530405	075530406
<b>7553N</b>	075530500	075530501	075530502	075530503	075530504	075530505	075530506
<b>7553V</b>	075530600	075530601	075530602	075530603	075530604	075530605	075530606

# 7548M

~~27,50 €~~  
**15,80 €**

Modern print t-shirt,  
100% cotton, 150 g/m<sup>2</sup>

# 7548C

~~27,50 €~~  
**15,80 €**

Classic print t-shirt,  
100% cotton, 150 g/m<sup>2</sup>



	XS	S	M	L	XL	2XL	3XL
<b>7548M</b>	075480400	075480401	075480402	075480403	075480404	075480405	075480406

	XS	S	M	L	XL	2XL	3XL
<b>7548C</b>	075480500	075480501	075480502	075480503	075480504	075480505	075480506

# 7550

~~44,50 €~~  
**25,00 €**

Technical work t-shirt, made from polyester, 120 g/m<sup>2</sup>,  
with 37.5® technology,



- Grey with black, orange and reflex details



	XS	S	M	L	XL	2XL	3XL
<b>7550G</b>	075500400	075500401	075500402	075500403	075500404	075500405	075500406
<b>7550N</b>	075500500	075500501	075500502	075500503	075500504	075500505	075500506

**PATENTED 37.5®**  
**HYPOALLERGENIC, SKIN-FRIENDLY TECHNOLOGY.**

**7860**

~~58,50 €~~  
**32,00 €**



**Work trousers in T/C twill, 180 g/m<sup>2</sup>, Beta EASY LIGHT**



- T/C twill, 65% polyester, 35% cotton; 180 g/m<sup>2</sup>
- T/C ripstop insets and knee pads
- Strap "Oxford" snap loop



	XS   46	S   48	M   50	L   52	XL   54	2XL   56	3XL   58	4XL   60	5XL   62
<b>7860B</b>	078600700	078600701	078600702	078600703	078600704	078600705	078600706	078600707	078600708
<b>7860G</b>	078600800	078600801	078600802	078600803	078600804	078600805	078600806	078600807	078600808

**7865**

~~93,80 €~~  
**52,00 €**



**Work overalls, lightweight**



- 65% polyester, 35% cotton
- Oxford inserts



	XS   46	S   48	M   50	L   52	XL   54	2XL   56	3XL   58	4XL   60	5XL   62
<b>7865B</b>	078650700	078650701	078650702	078650703	078650704	078650705	078650706	078650707	078650708
<b>7865G</b>	078650800	078650801	078650802	078650803	078650804	078650805	078650806	078650807	078650808

**7863G**

~~71,50 €~~  
**40,00 €**



**Work bib and brace overalls, lightweight New design - Improved fit**



**Beta EASY LIGHT**

	XS   46	S   48	M   50
	078630800	078630801	078630802
	L   52	XL   54	2XL   56
	078630803	078630804	078630805
	3XL   58	4XL   60	5XL   62
	078630806	078630807	078630808

**7861**

~~48,50 €~~  
**27,00 €**

**Work bermuda shorts, lightweight**

- Made from T/C twill, 180 g/m<sup>2</sup>, with Oxford inserts



	XS   46	S   48	M   50	L   52	XL   54
<b>7861B</b>	078610700	078610701	078610702	078610703	078610704
<b>7861G</b>	078610800	078610801	078610802	078610803	078610804
	2XL   56	3XL   58	4XL   60	5XL   62	
<b>7861B</b>	078610705	078610706	078610707	078610708	
<b>7861G</b>	078610805	078610806	078610807	078610808	

**Beta EASY LIGHT**



## 9526MC

095260020

**NEW**

~~264,00 €~~

**153,00 €**

**Capsule espresso coffee machine**



## 9563G

095630050

~~286,00 €~~

**143,00 €**

**Office armchairs, for guests**

- Back height: 60 cm
- Seat dimensions: 45 cm x 51 cm
- Overall chair height: 110-120 cm
- Base: 28 cm (leg length) x 50-60 cm (height)



## 9599CB-N2

095990031

~~748,00 €~~

**428,00 €**

**City bike Atala® 28"**



- Hi-Ten Tig TTK 700c frame
- Shimano® Tourney RD-TZ50 derailleur, 6-speed
- V-Brakes®
- 28" aluminium rims, double tube
- Battery lights
- Metal mudguard and chain guard
- Supplied with: pannier rack, stand and bell
- Colour: matt black

## 9566K

095660500

**NEW**

~~428,00 €~~

**259,00 €**

**Furnishing set, table and three stools, vertically adjustable**



## 9577R

~~167,00 €~~

**76,00 €**

**Work overalls, racing style, made from 4 way stretch fabric**

### STYLE

The accurate details as well as the colours and inspiration from the racing world result in a captivating, trendy garment.

### CONVENIENCE

The 4-WAY STRETCH fabric provides unique comfort for every movement.



	S	M	L	XL	2XL	3XL
	095770151	095770152	095770153	095770154	095770155	095770156

## 9574B

~~43,50 €~~

**21,00 €**

**Work gloves**

	M	L	XL	2XL
	095740102	095740103	095740104	095740105







2024 MOT02  
WORLD CHAMPIONSHIP

ALONSO LÓPEZ

FERMÍN ALDEGUER



**BETA POLSKA Sp. z o.o.**  
Skarbimierzyce, ul. Wiosenna 12, 72-002 Dołuje  
tel. 91 48 08 227, 91 48 08 236 fax: 91 48 08 219  
bok@beta-polska.pl www.beta-polska.pl